

**Contract for Stabilization of Hill Slope at
Malla near Bhatwari in District
Uttarakashi**

Time Based

Contract No. 03/ 2022-23

Between

PMU, Uttarakhand Forest Resource Management Project

And

**M/s Hindustan Builders and Developers
Head Office: Rajinder Nagar, Sahibabad
Ghaziabad - 201 005**

Dated: 07.12.2022



सत्यमेव जयते

INDIA NON JUDICIAL

Government of Uttarakhand

01

₹100

e-Stamp

₹100 ₹100 ₹100

Certificate No. : IN-UK22613422614246U
Certificate Issued Date : 07-Dec-2022 10:38 AM
Account Reference : NONACC (SV)/ uk1299704/ DEHRADUN/ UK-DH
Unique Doc. Reference : SUBIN-UKUK129970450825755969686U
Purchased by : HINDUSTAN BUILDERS AND DEVELOPERS
Description of Document : Article Miscellaneous
Property Description : NA
Consideration Price (Rs.) : 0
 (Zero)
First Party : HINDUSTAN BUILDERS AND DEVELOPERS
Second Party : NA
Stamp Duty Paid By : HINDUSTAN BUILDERS AND DEVELOPERS
Stamp Duty Amount(Rs.) : 100
 (One Hundred only)

सत्यमेव जयते



NAINA JOSHI
Stamp Vendor
Court Compound
DehraDun

Please write or type below this line

Form of Contract

The contract (herein after called the "Contract") is made on 07th day of December, 2022, between, Project Management Unit (PMU) of Uttarakhand Forest Resource Management Project (UFRMP) (herein after called the "Employer") and on the other hand M/s Hindustan Builders and Developers, Ghaziabad, each of whose directors shall be jointly and severally liable to the Employer for all the obligations under the contract, namely Vaibhav Garg, Proprietor (herein after collectively called the Contractor)



Project Director
Uttarakhand Forest Resource Management Project

Statutory Alert:

1. The authenticity of this Stamp certificate should be verified at 'www.shoilestamp.com' or using e-Stamp Mobile App of Stock Holding. Any discrepancy in the details on this Certificate and as available on the website / Mobile App renders it invalid.
2. The onus of checking the legitimacy is on the users of the certificate.
3. In case of any discrepancy please inform the Competent Authority.

WHEREAS

- A. The EMPLOYER has requested the contractor to provide certain services as defined in the Contract (herein after called the services)
- B. The CONTRACTOR, having represented to the client that it has the required professional skills, the experts and the technical resources, has agreed to provide the services on the terms and conditions set forth in this contract;

NOW THEREFORE the parties hereto and agree as follows:

1. The following documents attached hereto shall be deemed to form an integral part of this contract:
 - a) Summary of Price finalized
 - b) Item wise prices finalized as per BOQ
 - c) Tentative Work plan / schedule
 - d) The General Conditions of Contract
 - e) The Special Conditions of Contract
 - f) Technical specification
 - g) Design Drawings of Malla
 - h) Construction and Supervision Plan
 - i) Construction Quality Formats
 - j) Safety Manual for Slope work
2. The mutual rights and obligations of the client and the contractor shall be set forth in the contract, in particular:
 - a) The contractor shall carry out the services in accordance with the provisions of the contract.
 - b) The client shall make payments for the services to the contractor in accordance with the provisions of the contract.
 - c) Notwithstanding any other provisions of this contract, payments under this Contract shall not exceed **Rs.9,15,44,092.00 (Rs. Nine Crore Fifteen Lac Forty-Four Thousand Ninety-Two Only) (excluding GST as payable)** all in local currency (INR), except as otherwise agreed between the EMPLOYER and the CONTRACTOR.
 - d) The contractor shall submit Performance Guarantee as specified in the contract.



DY. PROJECT DIRECTOR
Uttarakhand Forest Resource Management Project

IN WITNESS WHEREOF, the parties hereto and hereby have caused this contract to be signed in their respective names as of the day and year first above written.

For and on behalf of the **EMPLOYER**
Uttarakhand Forest Resource Management Project

DY. PROJECT DIRECTOR
Uttarakhand Forest Resource Management Project

Dr. Koko Rose, Dy. Project Director

For and on behalf of the **CONTRACTOR**
M/s Hindustan Builders and Developers, Ghaziabad



Padam Nath Singh
General Manager

Contract No. 03/2022-23

Summary of Financial Bid

Site	Items	Amount in figures (in Rupees)	Amount in words (in Rupees)
MALLA	Stabilization of land-slid Hill slope in Malla near Uttarkashi - Construction of hill side works, retaining walls on slope, installation of erosion control mats, channeling of stream water, collection pits NH road construction and drainage channel upto suitable stream as per BOQ provided in Section V-B(ii)	₹ 9,15,44,092.41	Nine crores fifteen lakhs forty four thousand ninety two and paisa forty one only

DY. PROJECT DIRECTOR
Uttarakhand Forest Resource Management Project

Contract No. 03/2022-23

Summary of Financial Bid

Site	Items	Amount in figures (in Rupees)	Amount in words (in Rupees)
MALLA	Stabilization of land-slid Hill slope in Malla near Uttarkashi - Construction of hill side works, retaining walls on slope, installation of erosion control mats, channeling of stream water, collection pits NH road construction and drainage channel upto suitable stream as per BOQ provided in Section V-B(ii)	₹ 9,15,04,492.41	Nine crores fifteen lakhs forty four thousand ninety two and paisa forty one only



DY. PROJECT DIRECTOR
Uttarakhand Forest Resource Management Project

Contract No. 03/2022-23

BILL OF QUANTITY- MALLA

SL. NO.	DESCRIPTION OF ITEM	UNIT	QUANTITY	RATE IN FIGURES	RATE IN (WORDS)	AMOUNT (Rs.)
1.0	Excavation for Structures (Earth work in excavation of foundation of structures as per drawing and technical specifications, including setting out, construction of shoring and bracing, removal of stumps and other deleterious matter, dressing of sides and bottom, backfilling the excavation earth to the extent required and utilising the remaining earth locally for other work). Ordinary soil					
a.	Manual Means (Depth upto 3 m)	Cum	1,197.85	901.00	Nine hundred one	₹ 10,79,262.85
b.	Manual Means (Depth 3 m to 6 m)	Cum	798.57	1,129.00	One thousand one hundred twenty nine	₹ 9,01,585.53
c.	Mechanical Means (Depth upto 3 m)	Cum	2,196.06	156.00	One hundred fifty six	₹ 3,42,585.36
d.	Mechanical Means (Depth 3 m to 6 m)	Cum	2,794.99	191.00	One hundred ninety one	₹ 5,33,843.09
e.	Ordinary rock (not requiring blasting) Manual Means (Depth upto 3 m)	Cum	1,597.14	1,094.00	One thousand ninety four	₹ 17,47,271.16
f.	Manual Means (Depth 3 m to 6 m)	Cum	798.57	1,314.00	One thousand three hundred fourteen	₹ 10,49,320.98
g.	Mechanical Means (Depth upto 3 m)	Cum	2,395.71	210.00	Two hundred ten	₹ 5,03,099.10
h.	Mechanical Means (Depth 3 m to 6 m)	Cum	3,393.92	270.00	Two hundred seventy	₹ 9,16,358.40
i.	Hard rock (blasting prohibited) Mechanical Means	Cum	4,791.41	852.00	Eight hundred fifty two	₹ 40,82,281.32
2.0	Filling available excavated earth (excluding rock) in trenches, plinth, sides of foundations etc. in layers not exceeding 20cm in depth, consolidating each deposited layer by ramming and watering, lead up to 50 m and lift upto 1.5 m.	Cum	3,167.58	344.00	Three hundred forty four	₹ 10,89,647.52



DY. PROJECT DIRECTOR
Uttarakhand Forest Resource Management Project

SL. NO.	DESCRIPTION OF ITEM	UNIT	QUANTITY	RATE IN FIGURES	RATE IN (WORDS)	AMOUNT (Rs.)
3.0	Carrying of materials by mechanical transport including loading, unloading and stacking of excavated earth upto 5.0 km and all complete as per drawing and technical specifications.	Cum	6,211.96	378.00	Three hundred seventy eight	₹ 23,48,120.88
a.	Carrying of materials by mechanical transport including loading, unloading and stacking of excavated earth upto 2.0 km and all complete as per drawing and technical specifications.	Cum	Rate Only	385.00	Three hundred eighty five	
b.	Carrying of materials by mechanical transport including loading, unloading and stacking of excavated earth Beyond 5.0 km upto 10.0 km per km, all complete as per drawing and technical specifications. (On item at Sr. no. 3.0).	Cum	Rate Only	605.00	Six hundred five	
c.	Carrying of materials by mechanical transport including loading, unloading and stacking of excavated earth Beyond 10.0 km upto 20.0 km per km, all complete as per drawing and technical specifications. (On item at Sr. no. 3.0).	Cum	Rate Only	633.00	Six hundred thirty three	
4.0	Carrying of materials by mechanical transport including loading, unloading and stacking of excavated rock upto 5.0 km and all complete as per drawing and technical specifications.	Cum	9,317.94	474.00	Four hundred seventy four	₹ 44,16,703.56
a.	Carrying of materials by mechanical transport including loading, unloading and stacking of excavated rock upto 2.0 km and all complete as per drawing and technical specifications.	Cum	Rate Only	435.00	Four hundred thirty five	
b.	Carrying of materials by mechanical transport including loading, unloading and stacking of excavated rock Beyond 5.0 km upto 10.0 km per km, all complete as per drawing and technical specifications. (On item at Sr. no. 3.0).	Cum	Rate Only	522.00	Five hundred twenty two	
c.	Carrying of materials by mechanical transport including loading, unloading and stacking of excavated rock Beyond 10.0 km upto 20.0 km per km, all complete as per drawing and technical specifications. (On item at Sr. no. 3.0).	Cum	Rate Only	636.00	Six hundred thirty six	

DY. PROJECT DIRECTOR
Uttarakhand Forest Resource Management Project



SL. NO.	DESCRIPTION OF ITEM	UNIT	QUANTITY	RATE IN FIGURES	RATE IN (WORDS)	AMOUNT (RS.)
5.0	Centering and shuttering including strutting, propping etc. and removal of form work for: Retaining walls, return walls, walls (any thickness), catch basin, band work, etc. including attached pilasters, buttresses, plinth and string courses fillets, kerbs and steps etc.	Sqm	2,799.71	822.00	Eight hundred twenty two	₹ 23,01,361.62
6.0	Dismantling of Structures(Dismantling of existing structures like culverts, bridges, retaining walls and other structure comprising of masonry, cement concrete, wood work, steel work, including T&P and scaffolding wherever necessary, sorting the dismantled material, disposal of unserviceable material and stacking the serviceable material with all lifts and lead of 1000 metres)	Cum	153.70	1,110.00	One thousand one hundred ten	₹ 1,70,607.00
7.0	Plain/reinforced cement concrete in Basin, Band work, Retaining wall and other structures, etc complete as per drawings and technical specification of MORD clauses 802, 804, 805,806, 807,1202 & 1204. Grade of Concrete M 20 (For height upto 5 m)	Cum	1,653.64	9,884.00	Nine thousand eight hundred eighty four	₹ 1,63,44,577.76
8.0	Finishing of earthwork in slope surfaces as directed by UFRMP. All kinds of soil.	Sqm.	11,460.38	75.00	Seventy five	₹ 8,59,528.50
9.0	Supply and fixing of high porosity non-woven fabric soil erosion control mat made of crimped polyester fibre with natural vegetation function including galvanized coating anchor bar of 10mm dia. length 200 mm and anchor pin of 6 mm dia. length 150 mm and labour etc. complete as per drawing and technical specifications.	Sqm	13,023.16	1,315.00	One thousand three hundred fifteen	₹ 1,71,25,455.40



DY. PROJECT DIRECTOR
 Arakhand Forest Resource Management Project

SL. NO.	DESCRIPTION OF ITEM	UNIT	QUANTITY	RATE IN FIGURES	RATE IN (WORDS)	AMOUNT (Rs.)
10.0	Providing and fixing 0.9 m high G.I. barbed wire fencing with 1.2 m safeda balli post of 125mm dia. placed every 3.0 m centre-to-centre, 0.3 m below ground level, and provided with 3 horizontal line of G.I. barbed wires conforming to IS 278, fixed with GI staples, turn buckles etc. including digging of pits and backfilling all complete as per drawing and as directed by UFRMP.	Rmt.	751.00	1,370.00	One thousand three hundred seventy	₹ 10,28,870.00
11.0	Fence work in 100mm dia. wooden log of length 2.0 meter with 32mm dia. deformed bar of length 1.0 meter post 0.70 meter embedded in ground and bind with 2.6mm dia. wire to wooden log and iron post, complete as per drawing and Technical Specifications.	Meter	2,374.79	1,285.00	One thousand two hundred eighty five	₹ 30,51,605.15
12.0	Stone Masonry laid in 1:2 cement and coarse sand mortar, in channels, retaining walls and other structures, etc. including supply of all material, labour, T&P and royalties etc. complete as per drawing and technical specifications Clauses 702, 704, 1202 & 1203 of MORD Specifications. (Random Rubble Masonry)	Cum	1,316.28	8,074.00	Eight thousand seventy four	₹ 1,06,27,644.72
13.0	Supplying, laying, spreading and compacting crushed stone aggregate of sizes 90 mm to 45 mm in drains and other structures as per Table 400.8 of Technical Specifications of MORD in uniform thickness.	Cum	19.32	3,898.00	Three thousand eight hundred ninety eight	₹ 75,309.36
14.0	Supplying, laying, spreading and compacting crushed stone aggregate of sizes 90 mm to 45 mm as per Table 400.8 mixed with coarse sand in Retaining structures, Band works, Basin, Channel, Drains and other structures, etc. as per Technical Specifications of MORD in uniform thickness.	Cum	539.23	4,633.00	Four thousand six hundred thirty three	₹ 24,98,252.59



DY. PROJECT DIRECTOR
Uttarakhand Forest Resource Management Project

SL. NO.	DESCRIPTION OF ITEM	UNIT	QUANTITY	RATE IN FIGURES	RATE IN (WORDS)	AMOUNT (Rs.)
15.0	Gabion Structure for Retaining Earth (Providing and construction of a gabion structure for retaining earth with segments of wire crates of size 1.5 m x 1 m x 0.5 m, each divided into 0.75m compartments by cross netting, made from 4 mm galvanised steel wire @ 32 kg per 10 sqm having minimum tensile strength of 300 Mpa conforming to IS:280 and galvanizing coating conforming to IS:4826, woven into mesh with double twist, mesh size not exceeding 100 x 100 mm, filled with boulders with least dimension of 200 mm, all loose ends to be tied with 4 mm galvanised steel wire)	Cum	372.89	6,137.00	Six thousand one hundred thirty seven	₹ 22,88,425.93
16.0	Supply and fixing 9mm thick suction prevention material made of 100% polyester, of 1200 GSM, Tensile strength >18KN, Size of Aperture 0.12 micron and Elongation >50%, as per drawing and technical specifications.	Sqm	1,121.18	490.00	Four hundred ninety	₹ 5,49,378.20
17.0	Providing and fixing 5.0 mm thick MS sheet of approved make fixed with necessary nut, bolt/fastners, washers, etc. all inclusive and applying a coat of approved steel primer.	Sqm	37.40	5,886.00	Five thousand eight hundred eighty six	₹ 2,20,136.40
18.0	Providing and fixing Double Wall Corrugated 160 mm dia. Pipe with screen of approved make and conforming to IS 16098 (Part 2) in drain as per drawing.	Meter	69.00	4,539.00	Four thousand five hundred thirty nine	₹ 3,13,191.00
19.0	Providing and fixing 400-micron PVC water proof sheet of approved make below drain pipe as per drawing and technical specifications and as directed by UFRMP.	Sqm	173.49	212.00	Two hundred twelve	₹ 36,779.88



DY. PROJECT DIRECTOR
 Uttarakhand Forest Resource Management Project

SL. NO.	DESCRIPTION OF ITEM	UNIT	QUANTITY	RATE IN FIGURES	RATE IN (WORDS)	AMOUNT (Rs.)
20.0	Providing, laying and fixing of Empty Cement Bags(Gunny Bags) fixed with reinforcement anchor TMT bar of 20mm dia. & 1100 mm long of Fe 500D grade with (two or more coats) of enamel paint. Soil bag to be filled with soil & tightened, carriage upto site including preparing subgrade before placing in position, also including supply of all material, labour, T&P etc required for proper completion of the work as per specification & direction of Engineer-in charge.	Nos.	Rate Only	491.00	Four hundred ninety one	
21.0	Providing, laying and fixing of Empty Cement Bags(Gunny Bags) fixed with reinforcement anchor TMT bar of 20mm dia. & 1500 mm long of Fe 500D grade with (two or more coats) of enamel paint. Soil bag to be filled with soil & tightened, carriage upto site including preparing subgrade before placing in position, also including supply of all material, labour, T&P etc required for proper completion of the work as per specification & direction of Engineer-in charge.	Nos.	Rate Only	601.00	Six hundred one	
22.0	Providing and laying of Empty Cement Bags(Gunny Bags) filled with soil & tightened, carriage upto site including preparing subgrade before placing in position, also including supply of all material, labour, T&P etc required for proper completion of the work as per specification & direction of Engineer-in charge.	Nos.	Rate Only	164.00	One hundred sixty four	
23.0	Proving and fixing temporary rockfall protection fence using Sheet piling as per drawing and technical specifications of approx. 50 metres length.					
a.	Structural steel work in single section, fixed with or without connecting plate, including cutting, hoisting, fixing in position and applying a priming coat of approved steel primer all complete.	Kg.	2,877.42	169.00	One hundred sixty nine	₹ 4,86,283.98
b.	Plain/reinforced cement concrete in substructure complete as per drawings and technical specification Clauses 802, 804, 805, 806, 807, 1202 and 1204. (For height upto 5m) R.C.C. Grade M25.	Cum	62.40	9,592.00	Nine Thousand Five Hundred Ninety Two	₹ 5,98,540.80

SL. NO.	DESCRIPTION OF ITEM	UNIT	QUANTITY	RATE IN FIGURES	RATE IN (WORDS)	AMOUNT (Rs.)
c.	Proving and fixing U type Sheet pile PU12 or equivalent as per drawing and technical specifications. Yield Stress shall be min. 250N/mm ² and Tensile Strength shall be min. 410 N/mm ² .	Kg.	19,770.00	195.00	One hundred ninety five	₹ 38,55,150.00
24.0	Widening of NH					
a.	Cement Treated Crushed Rock or combination as per clause 403.2 and table 400.4 in Sub base/ Base (Providing, laying and spreading Material on a prepared sub grade, adding the designed quantity of cement to the spread Material, mixing in place with rotavator, grading with the motor grader and compacting with the road roller at OMC to achieve the desired unconfined compressive strength and to form a layer of sub-base/ base).					
i	For Sub-Base course	Cum	250.73	4,210.00	Four thousand two hundred ten	₹ 10,55,573.30
ii	For Base course	Cum	75.22	4,819.00	Four thousand eight hundred nineteen	₹ 3,62,485.18
b.	Wet Mix Macadam (Providing, laying, spreading and compacting graded stone aggregate to wet mix macadam specification including premixing the Material with water at OMC in mechanical mix plant carriage of mixed Material by tipper to site, laying in uniform layers with paver in sub- base / base course on well prepared surface and compacting with vibratory roller to achieve the desired density).	Cum	125.37	4,515.00	Four thousand five hundred fifteen	₹ 5,66,045.55
c.	Prime coat (Providing and applying primer coat with bitumen emulsion on prepared surface of granular Base including clearing of road surface and spraying primer at the rate of 0.60 kg/sqm using mechanical means).	Sqm	1,372.80	385.00	Three hundred eighty five	₹ 5,28,528.00
d.	Tack coat Providing and applying tack coat with bitumen emulsion using emulsion pressure distributor at the rate of 0.20 kg per sqm on the prepared bituminous/granular surface cleaned with mechanical broom.	Sqm	1,372.80	210.00	Two hundred ten	₹ 2,88,288.00



DY PROJECT DIRECTOR
 Uttarakhand Forest Resource Management Project

SL. NO.	DESCRIPTION OF ITEM	UNIT	QUANTITY	RATE IN FIGURES	RATE IN (WORDS)	AMOUNT (Rs.)
e.	Bituminous Concrete (Providing and laying bituminous concrete with 100-120 TPH batch type hot mix plant producing an average output of 75 tonnes per hour using crushed aggregates of specified grading, premixed with bituminous binder @ 5.4 to 5.6 % of mix and filler, transporting the hot mix to work site, laying with a hydrostatic paver finisher with sensor control to the required grade, level and alignment, rolling with smooth wheeled, vibratory and tandem rollers to achieve the desired compaction as per MORTH specification clause No. 509 complete in all respects, for Grading-I (bituminous binder @ 5.2 % of mix).	Cum	68.64	20,765.00	Twenty thousand seven hundred sixty five	₹ 14,25,309.60
f.	Type - A, "W" : Metal Beam Crash Barrier (Providing and erecting a "W" metal beam crash barrier comprising of 3 mm thick corrugated sheet metal beam rail, 70 cm above road/ground level, fixed on ISMC series channel vertical post, 150 x 75 x 5 mm spaced 2 m centre to centre, 1.8 m high, 1.1 m below ground/road level, all steel parts and fittings to be galvanised by hot dip process, all fittings to conform to IS:1367 and IS:1364, metal beam rail to be fixed on the vertical post with a spacer of channel section 150 x 75 x 5 mm, 330 mm long complete as per clause 810).	Rmt.	143.00	4,306.00	Four Thousand three hundred six	₹ 6,15,758.00
g	Laying Reinforced Cement Concrete Pipe NP4/prestressed concrete pipe of 1200 mm dia. on first class bedding in single row. (Laying Reinforced cement concrete pipe NP4/ prestressed concrete pipe for culverts on first class bedding of granular material in single row including fixing collar with cement mortar 1:2 but excluding excavation, protection works, backfilling, concrete and masonry works in head walls and parapets).	Rmt.	10.56	13,135.00	Thirteen thousand one hundred thirty five	₹ 1,38,705.60
h.	Supplying, fitting and placing TMT bar reinforcement in foundation complete as per drawings and technical specifications Clauses 1000 and 1202.	Kg.	24.65	149.00	One hundred forty nine	₹ 3,672.85
25.0	Construction of Temporary Access road 2.50 m wide of approx. 680 metres length for carrying of construction activities at slope.					₹

D.Y. PROJECT DIRECTOR
 UltraKhand Forest Resource Management Project



SL. NO.	DESCRIPTION OF ITEM	UNIT	QUANTITY	RATE IN FIGURES	RATE IN (WORDS)	AMOUNT (Rs.)
a.	Surface Drains in Soil, Construction of unlined surface drains of average cross-sectional area 0.40 sqm in soil to specified lines, grades, levels and dimensions. Excavated material to be used in embankment with a lift upto 3m and lead of 50 m (average lead 25 m) as per Technical Specification Clause 307.					
i	Manual Means	Rmt.	108.33	1,125.00	One thousand one hundred twenty five	₹ 1,21,871.25
ii	Mechanical Means	Rmt.	252.77	385.00	Three hundred eighty five	₹ 97,316.45
b.	Surface Drains in Ordinary Rock, Construction of unlined surface drain of average cross-sectional area 0.4 sqm in ordinary rock to specified lines, grades, levels and dimensions as per approved design and Technical Specification Clause 307. Excavated material to be used in embankment at site.					
i	Manual Means	Rmt.	108.33	1,010.00	One thousand ten	₹ 1,09,413.30
ii	Mechanical Means	Rmt.	252.77	415.00	Four hundred fifteen	₹ 1,04,899.55
c.	Dry stone pitching 22.5 cm thick including supply of stones and preparing surface complete.	Sqm	38.50	1,625.00	One thousand six hundred twenty five	₹ 62,562.50
26.0	Construction of Dumping zone for disposal of surplus earth and rocks from construction site to approved location as directed by UFRMP.					
a.	Laying of Geotextile sheet in drain around stone pitching to prevent escape of the embankment material through the voids of the stone pitching/cement concrete blocks as well as to allow free movement of water without creating any uplift head on the pitching.	Sqm	6,442.56	649.00	Six hundred forty nine	₹ 41,81,221.44



DY. PROJECT DIRECTOR
Haryana Forest Resource Management Project

SL. NO.	DESCRIPTION OF ITEM	UNIT	QUANTITY	RATE IN FIGURES	RATE IN (WORDS)	AMOUNT (Rs.)
b.	Supplying, filling, spreading & levelling stone boulders of size range 5 cm to 20 cm, in drain, in the required thickness, for all leads & lifts, all complete as per direction of Engineer-in-charge.	Cum	66.73	3,488.00	Three thousand four hundred eighty eight	₹ 2,32,754.24
c.	Provide and fixing Hard vinyl chloride (uPVC) 50mm dia. Pipe 6 KGF conforming to IS 4985 for Retaining wall weep hole as per drawing and technical specification.	Rmt	139.44	534.00	Five hundred thirty four	₹ 74,460.96
d.	Providing and fixing 20 mm thick compressible fibre board in expansion joint complete as per drawing and technical specifications.	Sqm	41.63	3,220.00	Three thousand two hundred twenty	₹ 1,34,048.60
					Total Cost excluding GST	₹ 9,15,44,092.41



DY. PROJECT DIRECTOR
Uttarakhand Forest Resource Management Project

WORK PLAN/SCHEDULE**Work Plan/Schedule of Completion for Malla near Uttarkashi**

Sr. No	Description of work	Start Date	End Date	Remarks
1	Widening of National Highway	01.04.23	31.10.23	Mob. Site setup, activity 2, Rainy season
	Above National Highway			
2	Temporary Rockfall Protection fence	01.03.23	31.03.23	
3	Temporary Road Construction	01.04.23	31.05.23	
4	Cut Slope Work (Surface dressing)	01.09.23	31.10.23	
5	Retaining Walls	01.11.23	31.05.24	
6	Fence Work	01.01.24	30.04.24	
7	Erosion Control Mat	01.02.24	30.04.24	
8	Channel and Band Works	01.10.23	30.09.24	
9	Catch Basin	01.12.23	30.09.24	
	Below National Highway	01.09.23	31.10.23	
10	Retaining Walls	01.01.24	30.11.24	
11	Channel and Band Works	01.03.24	31.10.24	
12	Fence Works	01.04.24	31.10.24	
13	Erosion Control Mat	01.05.24	30.11.24	
14	Gabion	01.01.24	30.11.24	
	Total Completion Period for MALLA			24 Months

Bar Chart for work schedule also enclosed.



 DY. PROJECT DIRECTOR
 Uttarakhand Forest Resource Management Project

Bar Chart for Malla near Uttarkashi

Stabilization of debris flow and controlling water flow in Malla																											
Detailed Construction Schedule																											
Note: Considering the date of start 01-01-2023																											
S.No	Activities	Months	Jan-23	Feb-23	Mar-23	Apr-23	May-23	Jun-23	Jul-23	Aug-23	Sep-23	Oct-23	Nov-23	Dec-23	Jan-24	Feb-24	Mar-24	Apr-24	May-24	Jun-24	Jul-24	Aug-24	Sep-24	Oct-24	Nov-24	Dec-24	
1	Mobilization	2.0																									
2	Site setup & getting approvals	2.0																									
Part-A-Alongside of NH																											
3	Rock fall protection fence	1.0																									
4	Widening of NH with Pipe culvert	4.0																									
Part-B (Upper slope area)																											
5	Temporary road construction	2.0																									
6	Cut slope work(Surface dressing)	2.0																									
7	Retaining walls (Gabion)	7.0																									
8	Fence work	4.0																									
9	Erosion control Mat	3.0																									
10	Channel & Band works	9.0																									
11	Catch basin	7.0																									
Part-C (Bottom Slope area)																											
12	Access road to bottom slope area	2.0																									
13	Retaining walls (Concrete & Gabion)	8.0																									
14	Channel & Band works	5.0																									
15	Fence work	4.0																									
16	Erosion control Mat	4.0																									
17	Other works	3.0																									
18	Clean up & Handover																										

Rainy Season

Rainy Season



DX PROJECT DIRECTOR
Uttarakhand Forest Resource Management Project

**GENERAL
CONDITIONS
OF
CONTRACT**

1. Definitions

Terms which are defined in the Contract Document other than those defined hereunder shall keep their respective meanings as defined therein.

- i. The **Contract** means the legally binding written agreement including all the attachments and information signed between the Employer and the Contractor herein, to execute & complete the works in a specified time and thereafter to maintain and correct them during the defect liability period specified therein.
- ii. **Bill of Quantities (BOQ)** means the priced and completed Bill of Quantities forming part of the Contract.
- iii. The **Completion Date** is the actual date of completion of the Works as certified by the Employer in accordance with relevant sub-clauses below.
- iv. The **Contractor** is the Firm whose bid has been accepted by the Employer to carry out the Works, as specified in this contract.
- v. The **Contract Price** is the price stated in the Contract and thereafter as adjusted in accordance with the provisions of the Contract.
- vi. **Days** are calendar days; **months** are calendar months and **years** are calendar years.
- vii. A **Defect** is any part of the Works not completed in accordance with the Contract.
- viii. The **Defects Liability Period** is the period specified in the Contract and calculated from the actual Completion Date.
- ix. The **Employer** is the authority named in the Contract (or any other competent authority working under him, authorized and notified to the contractor) who will employ the Contractor to execute this Contract.
- x. The **Employer's Representatives** are the persons specified in the Special Conditions of the Contract (SCC).
- xi. **Equipment** is the Contractor's machinery (including Tools & Plants) and vehicles brought temporarily to the site for proper execution of works.
- xii. **GCC** means the General Conditions of Contract.
- xiii. The **Intended Completion Date** is the date on which it is intended that the Contractor shall complete the works. The Intended Completion Date is specified in the Contract. The Intended Completion Date may be revised/ extended only by the competent authority by issuing an official letter specifying the extension of Contract.
- xiv. **Materials** are all supplies, including consumables, intended to be used and brought to site / site store, including their quantity actually consumed, by the Contractor in the Works.



DY PROJECT DIRECTOR
Uttarakhand Forest Resource Management Project

- xv. **Party** means the Employer or the Contractor, as the case may be, and "Parties" means both of them.
- xvi. **Plant** is any integral part of the Works which is to have a mechanical, electrical, electronic or chemical or biological function.
- xvii. The **Site** is the project area as defined in the Contract.
- xviii. **Site Investigation Reports** are those which are either included in the Bidding documents, or required to be submitted by the Contractor therein after conducting the specified site investigations, and are factual interpretative reports about the surface and sub-surface conditions at the site.
- xix. **Specifications** mean the Specifications of the Works included in the Contract and any modifications or additions made/approved by the Employer for proper execution and completion of works.
- xx. The **Start Date** is the date when the Contractor is required to commence the execution of contracted works.
- xxi. **Temporary Works** are the works which are designed, constructed and installed by the Contractor, needed for proper construction or execution of the Works and are to be removed thereafter.
- xxii. "**Third Party**", means any person or entity other than the Employer and the Contractor.
- xxiii. A **Variation** is the difference in quantities of works resultant to any instructions duly given by the Employer either in writing or verbally which varies from the Works as specified in BOQ.
- xxiv. **Compensation Events** is the situation which would prevent works to be completed on or before the Intended Date of Completion except the conditions under Force Majeure.
- xxv. The **Adjudicator** (synonymous with the Dispute Review Expert) is the person appointed jointly by the Employer and the Contractor to resolve disputes in the first instance.

2. Interpretation

In interpreting these General Conditions of Contract, singular also means plural, male also means female or neutral, and the other way round. Headings have no significance. Words have their normal meaning under the language of the Contract unless specifically defined.

3. Personnel

The Contractor shall employ the key personnel named in the Schedule of Key Personnel as referred to in the Contract, to carry out their functions for proper execution and completion of works stated in the proposal. The Employer may ask the Contractor for replacement of any key personnel listed in the proposal if his services are not found to be satisfactory with the personnel having equivalent or better qualifications, abilities, and relevant work experience.

If the Employer ask the Contractor to remove a person who is a member of the Contractor's staff or his work-force stating the reasons, the Contractor shall ensure that the person leaves the Site immediately and has no further connection with the work in the Contract.

The contractor shall not remove or replace any personnel mentioned in their proposal without prior permission from the Employer.



DI PROJECT DIRECTOR
Uttarakhand Forest Resource Management Project

4. Force Majeure

- (i) For the purpose of this Contract "Force Majeure" means an event which is beyond the reasonable control of Employer or Contractor, is not foreseeable, is unavoidable, and which makes performance and its obligations hereunder impossible or so impractical, as reasonable to be considered impossible in the circumstances, and includes, but is not limited to war, riots, civil disorder, earthquake, fire, explosion, storm, flood or other adverse weather conditions.
- (ii) Force Majeure shall not include (a) any event which is caused by the negligence or intentional action of Employer or Contractor, (b) any event which through diligence could reasonably have been expected to take into account at the time of the conclusion of this contract, avoid or overcome in the carrying out of its obligations hereunder.
- (iii) Force Majeure shall not include insufficiency of funds or failure to make payment required.

5. Employer's / Contractor's Obligations and Liquidated Damages

The Employer carries the risks which this Contract states are Employer's risks, and the Contractor carries the risks which this Contract states are Contractor's risks.

6 (i) Employer's Risks

The Employer is responsible for the expected risks which are specified below:

- (a) the risks mentioned under force majeure in so far as they directly affect the execution of the Works, or
- (b) a cause due, solely, to the design of the Works, other than the Contractor's design, or
- (c) dispute by villagers on land / source / alignment etc., or
- (d) non availability of funds, or

6 (ii) Contractor's Risks

All risks of loss of, or damage to,

- (a) the risks mentioned under force majeure in so far as they directly affect the execution of the Works, or
- (b) Physical property (either pertaining to the Contracted Works or to the Employer or any Third Party)
- (c) Personal injury or death (of Contractor's staff / member of work-force or the Employer's staff or any Third Party) which arise during and in consequence of the performance of the Contract,

6 (iii) Liquidated Damages

The Contractor shall pay liquidated damages to the Employer at the rate per week stated in the Contract for each week that the Completion Date is later than the Intended Completion Date (for the whole of the works or the milestone as stated in the contract document). The total amount of liquidated damages shall not exceed the amount defined in the Contract. The Employer may deduct liquidated damages from payments due to the Contractor. Time is the essence of the contract and payment or deduction of liquidated damages shall not relieve the contractor from his obligation to complete the work as per agreed construction program and milestones or from any other of the contractor's obligations and liabilities under the contract.

If the Intended Completion Date is extended after liquidated damages have been paid, the Employer shall correct any overpayment of liquidated damages by the Contractor by adjusting the next payment certificate.

6. Release from Performance



[Signature]
 PROJECT DIRECTOR
 Uttarakhand Forest Resource Management Project

If the contract is frustrated by the events which come under force majeure or any other event entirely outside the control of either the Employer or the contractor, the Employer shall certify that the contract has been frustrated. The contractor shall make the Site safe and stop work as quickly as possible after receiving this certificate and shall be paid for all work carried out before receiving it and for any work carried out afterwards to which commitment was made.

7. Insurance

The Contractor, at his own cost shall provide, insurance cover from the Start Date to the end of the Defects Liability Period, in the amounts and deductibles for the following events which are related to the Employer's risks and Contractor's risks:

- (a) loss of or damage to the Works, Plant and Materials;
- (b) loss of or damage to Equipment;
- (c) loss of or damage of property (except the Works, Plant, Materials and Equipment) in connection with the Contract; and
- (d) personal injury or death.

8. Contractor to Construct the Works

The Contractor shall make necessary arrangements, at his own cost, for detailed survey to verify the actual availability and levels of suitable site locations for different components of works, and shall intimate his findings to the Employer in writing. If any significant change from the approved design is found, then the Contractor shall get the designs and drawings modified accordingly, at his own cost, in compliance of Employer's written directions for the same and shall get such modified designs and drawing approved by competent technical authority, through the Employer, before procurement of material for works and actually starting the execution of works. The contractor shall construct and install all the Works in accordance with the approved Specifications of works and as per the approved Designs and Drawings, and also ensuring the compliance of the Employer's instructions. The Contractor shall be solely responsible for proper workmanship, timely completion and due performance of all the works.

9. Protection of Environment:

The contractor shall take all reasonable steps to protect the environment on and off the Site and to avoid damage or nuisance to persons or to property of the public or others resulting from pollution, noise or other undesirable causes arising as a consequence of his methods of operation. During continuance of the contract, the contractor and his sub-contractors shall, at all times, abide by all existing enactments on environmental protection and rules made there under, regulations, notifications and bye-laws of the State or Central Government, or local authorities and any other law, bye-law, regulations that may be passed or notification that may be issued in this respect in future by the State or Central Government or the local authority.

10. The Works to Be Completed by the Intended Completion Date

The Contractor shall make all efforts to commence the execution of the works on the Start Date and shall carry out the Works in accordance with the time schedule submitted by the Contractor and duly approved by the Employer. This time schedule shall invariably be within the framework of the milestones prescribed in Contract, in order that all the works are completed in all respect by the Intended Completion Date.



DR. PROJECT DIRECTOR
Uttarakhand Forest Resource Management Project

11. Approval by the Employer

- Before start of any work, the Contractor will submit the detailed methodology for execution of works and get the same approved by the employer. The employer has provided the Specifications, Designs, Drawings & Site Plan showing locations of all the proposed Temporary Works, required to execute the Contract.
- Based on the design drawings provided by Employer the Contractor will resurvey the area and submit revised shop drawings in case of any change in design and get the same approved prior to start of the work.
- The Contractor shall solely be responsible for safe design of Temporary Works and safety of all materials / machinery / equipment's etc. stored / placed for this purpose and all residing / handling personnel.
- The Employer's approval shall not relieve the Contractor of his responsibility of proper design and safety of the Temporary Works.
- The Contractor shall obtain any required approval for design and layout of the Temporary Works or any other activity, if required, from concerned competent authority.

12. Safety

The Contractor shall be responsible for the safety of all activities on the site as per the schedule of safety measures attached as "Safety Manual for Slope Work"

13. Access to the Site

The Contractor shall always allow the Employer and any person authorized by the Employer, access to the Site or to any place where work in connection with the Contract is being carried out or is intended to be carried out and to any place where materials or plants are being installed/ manufactured / fabricated / assembled / stored for the works.

14. Contractor's Records

The Contractor shall permit the Employer to inspect the Contractor's accounts and records relating to the performance of the Contractor and to have them audited by auditors appointed by the Employer, if so required by the Employer.

15. Procedure for Settlement of Disputes

The Parties shall seek to resolve any dispute amicably by mutual consultation.

In case any dispute arises due to any reason with respect to execution of the Contract, the objecting party shall give in writing the cause of dispute to the other party providing in detail the basis of the dispute. The party receiving the notice of dispute will consider it and respond in writing within 14 days after receipt. The parties shall make efforts to resolve the dispute amicably through consultation and mutual agreement. However, either of the parties, if not satisfied, may go for the settlement of the dispute as per applicable law.

16. Arbitration

If the dispute cannot be settled amicably pursuant to clause 15 of GCC, such dispute or disagreement shall be finally settled under the rules of Arbitration, as applicable, by one or more arbitrators,



DY. PROJECT DIRECTOR
Uttarakhand Forest Resource Management Project

appointed in accordance with the said Rules, and the proceedings shall be held in a neutral venue selected in accordance with these Rules of Arbitration. The award in any Arbitration proceedings shall be final and binding upon the Contractor as well as Employer and judgement thereon may be entered in any court of competent jurisdiction on application of either party.

For this Contract the jurisdiction shall be Dehradun/ Uttarakhand state.

17. Time Schedule

Within the time schedule stated in the Contract and the milestones specified therein, the Contractor shall submit to the Employer for approval of a detailed time schedule for execution of the Works including Environmental Management Plan showing the general methods, arrangements, sequence and detailed timing for all the activities necessary for the Works along with monthly cash flow forecast. This time schedule shall necessarily include PERT Chart as well as Bar Chart of all the activities.

An updated time schedule shall be a time schedule showing the actual progress achieved on each activity and the effect of the progress achieved on the timing of the remaining works including any changes to the sequence of the activities required for timely completion of works within the Intended Completion Date.

18. Compensation Events

The following are Compensation Events unless they are caused by the Contractor:

- a) The Employer does not give access to a part of the Site by the Site Possession Date stated in the contract document.
- b) The Employer modifies the schedule of other contractors in a way which affects the work of the contractor under the Contract, in case it relates with the work under the contract.
- c) The Employer orders a delay or does not issue drawings, specifications or instructions required for execution of works.
- d) The employer instructs for specific safety or other countermeasures at site other than as per BOQ. The works are to be carried out on steep slopes so extensive safety countermeasures might be required to be executed on site for safe and proper execution of the works as per the contract.

In the event of above conditions contractor shall be liable to be paid as per BOQ. If the item is not in the approved BOQ same shall be compensated as per SOR/DSR. However, in case the item is available both in SOR and DSR the preference shall be given to SOR.

If a Compensation Event would prevent the work being completed on or before the Intended Completion Date, the Intended Completion Date may be extended. The Employer shall decide whether and by how much the Intended Completion Date shall be extended.

The Contractor shall not be entitled to compensation to the extent if the Employer's interests are adversely affected by the Contractor not having given early warning or not having cooperated with the Employer.

19. Extension of the Intended Completion Date

The Employer may extend the Intended Completion Date, if a Compensation Event occurs or a Variation is necessitated which makes it impossible for Completion to be achieved by the Intended Completion Date without taking additional steps to accelerate the remaining work and which would cause the Contractor to incur additional costs.



DY. PROJECT DIRECTOR
Uttarakhand Forest Resource Management Project

The Employer shall decide whether to extend and by how much to extend the Intended Completion Date, within 30 days of the Contractor asking the Employer for a decision, upon the effect of a Compensation Event or Variation by submitting full supporting information. If the Contractor fails to give in writing to the Employer early warning of a possible delay or fails to notify the Employer about the hindrances causing unavoidable and justifiable delay, which is beyond his control, within a week of commencement of such delay / hindrance or fails to deal with the hindrances responsible for any avoidable delays, such delays shall not be considered in assessing the new Intended Completion Date. Employer's decision regarding the Contractor's failure to deal with avoidable delays due to any reason shall be final and binding. The delay in procurement of material for whatsoever reason, except due to natural calamities, shall also not be considered for extension of Intended Completion Date.

20. Delays Ordered by the Employer

The Employer may instruct the Contractor to delay the start or progress of any activity within the Works, at any time during the currency of the Contract, if he considers it proper in the interest of works or for safety of works / staff / material / third party. The Contractor shall not be entitled to any compensation for such delays, but the Employer may consider the same for extension of Intended Completion Date.

21. Management Meetings

The Employer may require the Contractor to attend a Management Meeting at any time during progress of work. The objective of a Management Meeting shall be to review the progress and plans for the remaining works and to deal with matters raised in accordance with the early warning procedure.

The Employer shall record the minutes of Management Meetings and shall provide copies of the same to all those attending the meeting and to the Employer's Representative. The responsibility for actions to be taken is to be decided by the Employer either during the Management Meeting or after the Management Meeting and shall inform about it in writing to all concerned.

22. Early Warning

It shall be the duty of the Contractor to give an early warning, in writing, to the Employer at the earliest regarding specific likely future events or circumstances that may adversely affect the progress of work or quality of the work or delay the execution of works or likely to increase the Contract Price.

23. Identifying Defects & Shortcomings

The Employer shall check the Contractor's work, but such checking shall not relieve the Contractor of his responsibilities regarding correctness, quality and quantity of works in any manner. The Employer shall notify the Contractor of any defects or shortcomings that are found and shall instruct the Contractor to search for a defect or shortcoming and to uncover and test any work which may have a defect or shortcoming in their opinion.

The contractor shall permit the Employer or their representative or any Technical Auditor / Third Party designated by Employer to check the contractor's work and to notify the Contractor of any defects or shortcomings that are noticed during inspections. Such a check shall neither relieve the Contractor's responsibilities regarding specifications as defined in the Contract nor shall relieve him from any responsibilities regarding proper performance of works.

24. Testing of Materials

All the civil construction and other materials & fittings supplied (other than the materials provided by Employer if any) shall be got tested at site at contractor's facility prior to installation, or through IIT,



DY. PROJECT DIRECTOR
Uttarakhand Forest Resource Management Project

Roorkee or any other Institution of repute approved by the Employer, by the contractor at his own expense. If the test report doesn't conform to relevant Specifications / IS Standards, the contractor will replace such defective materials from site within a week of receipt of the report, at his own cost. The materials or fittings required to be tested prior to installation shall not be installed until the Employer has approved the test results. The number of samples to be tested will be decided as per the directions of Employer. All the samples shall be drawn and sealed jointly by the Contractor / his Authorized Representative and the Employer / his Authorized Representative.

25. Completion and Commissioning of Work

The Contractor shall ensure to complete and commission the Work before or on the day of the Intended Completion Date as defined in Contract. One month before the end of completion period, the Contractor shall request the Employer to issue a certificate of completion of the works and the Employer will do so after inspecting the works by himself through technical Audit / Third Party Quality Control team and certify that the work has been completed as per the specifications within the completion period as defined in the contract document.

Note: In certain cases, where the technical specifications provide for acceptance of works within specified tolerance limits at reduced rates, Employer will certify payments to Contractor accordingly.

26. Correction of Defects

The Employer shall give notice to the Contractor of any Defects noticed during the Defects Liability Period, which begins after the date of successful Completion and is defined in the contract.

Every time notice of a Defect is given, the Contractor shall correct the notified Defect within the length of time specified in the Employer's notice.

27. Uncorrected Defects

If the Contractor has not corrected a Defect within the time specified in the Employer's notice, the Employer will get the Defects corrected at the Contractor's cost and the cost so incurred will be deducted from pending bills due to the Contractor and the retention money.

28. Cost of Repairs

Loss or damage to the Works or Materials to be incorporated in the Works between the Start Date and the end of the Defects Liability period shall be remedied by the Contractor at the Contractor's cost if the loss or damage arises from the Contractor's acts or omissions.

29. Changes in the Quantities (Variation)

If the quantity of the work to be executed differs from the quantity in the Bill of Quantities for the particular item, it should be brought to the notice of the Employer by the Contractor before the execution of work. After verification of the facts, Employer will approve for such variations in quantities of the Contract.

30. Payment Certificates

The Contractor shall submit to the Employer monthly statements of the estimated value of the work completed, measured jointly with the Employer's Site Engineer, less the cumulative amount certified previously along with details of measurement of the quantity of works executed in a tabulated form by 25th day of every month along with amounts to be paid which is due against the executed works.



DY. PROJECT DIRECTOR
Uttarakhand Forest Resource Management Project

The Employer shall further check the details given in the monthly statement and certify the amounts to be paid to the Contractor after taking into account any credit or debit for the month in question in respect of materials for the works in the relevant amounts and under conditions set forth in Sub Cl. 32 of G.C.C.

The value of work executed shall be determined by the Employer after due check measurement of the quantities claimed as executed by the Contractor, shall comprise the value of the quantities of the items in the Bill of Quantities completed and shall include the valuation of Variations as approved by the Employer.

31. Payments

(i) Contract Price

The Contract price shall be fixed till the end date as per the contract. However, in the event of unforeseen circumstances if so ever the time extension is awarded to the contractor the price escalation shall be applicable on the uncompleted works.

(ii) Release of Payments

Payments shall be adjusted for deductions of advance payments and other recoveries in terms of the contract and taxes, at source, as applicable under the law. The Employer will clear all payments / amount due against the completed works found to be satisfactory shall be released within 21 days from the date of such claims submitted by the contractor.

32. Tax

The rates quoted by the Contractor shall be exclusive of the GST as per your financial proposal which shall be payable at actuals. The Employer will release payments after deduction of all taxes payable at source as per applicable law.

33. Currencies

All payments shall be made in Indian Rupees.

34. Penalty

In case of non-completion / delay in completion of Works as scheduled, amount, as mentioned in the Special Conditions of Contract (SCC), as penalty shall be deducted.

35. Advance Payment and Advance Bank Guarantee

The Employer shall make advance payment to the Contractor of the amounts stated in the Contract by the date stated in the Contract, against provision by the Contractor of an unconditional Bank Guarantee by a bank acceptable to the Employer in amounts and currencies equal to 100% the advance payment. Simple interest @ 10% shall be chargeable on the unadjusted advance payments. The Advance Bank Guarantee shall remain effective until the advance payment has been repaid, but the amount of the guarantee shall be progressively reduced by the amounts repaid by the Contractor.

36. Performance Security

The Performance Security shall be provided to the Employer not later than the date specified in the Contract and shall be issued for an amount and in the form of a bank guarantee (BG) acceptable to the Employer, and denominated in Indian Rupees. The Performance Security BG shall be valid until a date 28 days from the date of expiry of Defects Liability Period.



DY. PROJECT DIRECTOR
Uttarakhand Forest Resource Management Project

37. Completion

The Contractor shall request the Employer to issue a Certificate of Completion of the Works and the Employer will do so upon deciding that the Work is completed in accordance with relevant clauses.

38. Taking Over

The Employer shall take over the Site and the Works within fifteen days after certificate of completion has been issued.

39. Final Account

The Contractor shall supply to the Employer a detailed account of the total amount that the Contractor considers payable under the Contract before the end of the Defects Liability Period. The Employer shall issue a Defect Liability Certificate stating that all the defects have been rectified and certify any final payment that is due to the Contractor within 40 days of receiving the Contractor's account if it is correct and complete. If it is not, the Employer shall issue a schedule that states the scope of the corrections or additions that are necessary. If the Final Account is still unsatisfactory after it has been resubmitted, the Employer shall decide on the amount payable to the Contractor and issue a payment certificate, within 40 days of receiving the Contractor's revised account.

40. Termination

The Employer may terminate the Contract if the other party causes a breach of the Contract, or any of the clauses of the contract are not complied by the contractor.

If the Contract is terminated the Contractor shall stop work immediately, handover the site along with the work executed and materials available at the site up to the date of termination. The Employer shall immediately takeover the site along with the materials on 'As is where is basis' and make it safe and secure.

Breach of contract by the contractor may result in following consequences, as decided by the Employer: -

- i. Performance security submitted by the contractor can be forfeited.
- ii. Rescind the contract (of which rescission notice in writing to the contractor under the signature of the Employer shall be conclusive evidence), in which case the security deposit of the contractor together with such sum or sums due to him under the contract shall stand forfeited and be absolutely at the disposal of the Employer.
- iii. Take legal action against the Contractor if the breach of the contract is related to Fraud and Corruption.
- iv. Blacklist the Contractor and debar him for award of any other contracts.

41. Other Conditions for termination

- (a) the Contractor stops work for 28 days when no stoppage of work is shown on the current time schedule and the stoppage has not been authorized by the Employer;



DX PROJECT DIRECTOR
Uttarakhand Forest Resource Management Project

- (b) the Employer gives Notice to correct a particular Defect and the Contractor fails to correct it within the specified period of time determined by the Employer;
- (c) the Contractor does not maintain security of the works executed or in progress;
- (d) the Contractor has delayed the completion of works by the number of days for which the maximum amount of liquidated damages can be paid as defined in the Contract;
- (e) The contractor does not adhere to the agreed construction time schedule and also fails to take satisfactory remedial action as per agreements reached in the management meetings for a period of 40 days.
- (f) The contractor fails to carry out the instructions of Employer within the specified time determined.

41. Property

All materials on the Site, Plant, Equipment, Temporary Works and Works are deemed to be the property of the Employer, if the Contract is terminated because of a Contractor's default. The Employer will assess the cost of utilizable materials lying at site, which will be final and binding to the Contractor and will be deemed to be the property of the Employer. The Employer will be free to use the materials for the Works under the present project or any other project.

42. Fraud and Corruption

The Employer requires that Contractor, and Consultants under this contract, observe the highest standard of ethics during the procurement and execution of such contracts. In pursuit of this policy, the Employer defines, for the purposes of this provision, the terms set forth below as follows:

- a. "Corrupt practice" means the offering, giving, receiving, or soliciting, directly or indirectly, of anything of value to influence the action of a public official in the procurement process or in contract execution; "fraudulent practice" means a misrepresentation or omission of facts in order to influence a procurement process or the execution of a contract;
- b. "Coercive practice" means harming or threatening to harm, directly or indirectly, persons or their property to influence or affect the execution of the contract.

XXX



DY. PROJECT DIRECTOR
Uttarakhand Forest Resource Management Project

**SPECIAL CONDITIONS
OF
CONTRACT**

Special Conditions of Contract

The Special Conditions of Contract (SCC) complement the General Conditions of Contract (GCC) to specify data and contractual requirements linked to special circumstances of the sites where the Contract is to be executed. Whenever there is a conflict, the provisions herein shall prevail over those in the GCC.

Clause nos. in the SCC correspond to those in the GCC.

S.No.	Clause no. of GCC	Amendments of, and supplements to, Clauses in the General Conditions of Contract.
1	—	The Contractor shall be construed as per law under Government of Uttarakhand and Government of India.
2		<p>The Name and Address of the parties are</p> <p>Employer: Mr. Anup Malik, Chief Project Director, or the person(s) authorized by the Chief Project Director, Uttarakhand Forest Resource Management Project (UFRMP) 24, IT Park, Dehradun- 248001 Telephone: +91 135 2976200 Email: cpdufrmp@gmail.com</p> <p>Contractor: Mr. Vaibhav Garg, Proprietor Hindustan Builders and Developers Rajinder Nagar, Sahibabad Ghaziabad - 201005 Mobile: +91 Email: hindustanbuildersndevlopers@gmail.com</p>
3	1.xi	The Employer's Representative are Chief Project Director (CPD) or the persons so authorized by him from time to time.
4	32(i)	The total contract value shall be Rs.9,15,44,092.00 (Rs. Nine Crore Fifteen Lac Forty-Four Thousand Ninety-Two Only) (excluding GST as payable)
5	1.xx	Start Date shall be date of signing of the contract.
6	10,25	The completion period for the project shall be 24 months and shall be counted from the start date.



DY. PROJECT DIRECTOR
 Uttarakhand Forest Resource Management Project

Special Conditions of Contract

The Special Conditions of Contract (SCC) complement the General Conditions of Contract (GCC) to specify data and contractual requirements linked to special circumstances of the sites where the Contract is to be executed. Whenever there is a conflict, the provisions herein shall prevail over those in the GCC.

Clause nos. in the SCC correspond to those in the GCC.

S.No.	Clause no. of GCC	Amendments of, and supplements to, Clauses in the General Conditions of Contract.
1	—	The Contractor shall be construed as per law under Government of Uttarakhand and Government of India.
2		<p>The Name and Address of the parties are</p> <p>Employer: Mr. Anup Malik, Chief Project Director, or the person(s) authorized by the Chief Project Director, Uttarakhand Forest Resource Management Project (UFRMP) 24, IT Park, Dehradun- 248001 Telephone: +91 135 2976200 Email: cpdufrmp@gmail.com</p> <p>Contractor: Mr. Vaibhav Garg, Proprietor Hindustan Builders and Developers Rajinder Nagar, Sahibabad Ghaziabad - 201005 Mobile: +91 Email: hindustanbuildersndevlopers@gmail.com</p>
3	1.xi	The Employer's Representative are Chief Project Director (CPD) or the persons so authorized by him from time to time.
4	32(i)	The total contract value shall be Rs.9,15,44,092.00 (Rs. Nine Crore Fifteen Lac Forty-Four Thousand Ninety-Two Only) (excluding GST as payable)
5	1.xx	Start Date shall be date of signing of the contract.
6	10,25	The completion period for the project shall be 18 months and shall be counted from the start date.



DI. PROJECT DIRECTOR
 Uttarakhand Forest Resource Management Project

Special Conditions of Contract

7	35	The Advance Bank Guarantee (ABG) shall be submitted by the contractor within 7-10 days after the signing of contract for value equivalent to the advance amount.
7	36	The Performance Bank Guarantee (PBG) for an amount equivalent to 5% of the contract value valid until completion of the Defect Liability Period shall be submitted by the contractor within 90 days from the date of signing of the contract
8	30,31,32,35	The terms of Payment shall be as follows: 20% of the contract value shall be released as mobilization advance (at 10 % simple interest on the unadjusted advance payments) against Advance Bank Guarantee of value equal to 100 % of the Mobilization advance. Balance amount shall be paid on pro rata basis of the works completed on monthly basis. The advance paid against ABG shall be deducted from the interim bills to be claimed by the contractor on monthly basis.
9	34	Penalty: A penalty equivalent to 0.5% of the rates of works / items which the Contractor has failed to complete / deliver for each week or part of week, subject to a maximum of 5% of value of such works / item.
10	26,27,28	Defect Liability Period shall be one year from the Intended Date of Completion of works at respective sites.
11	30	Payment for Variation: Shall be as per the approval of the Employer.

XXX



DY. PROJECT DIRECTOR
Uttarakhand Forest Resource Management Project

Technical specification

1.	Preamble	48
2.	General	48
3.	Earth Work and Excavation	52
4.	Concrete and Allied Works	60
5.	Brick and Stone Masonry	94
6.	Expansion Joints	97
7.	Hydro-seeding & Vegetation regeneration	97
8.	Covering/ Slope Protection Works	99
9.	Seeding and Mulching	102
10.	Fence Work	104
11.	Erosion Control Mat	106



[Signature]
Chief Engineer
 Technical Cooperation Project
 Uttarakhand Forest Resource Management Project
 NTFP Centre, 49, IT Park
 Dehradun-248001

1. PREAMBLE

The "Specifications" are to be read for the purpose of pricing in conjunction with Bid documents containing Instructions to Bidders and "Financial Bid".

The prices quoted in the Financial Bid shall be all inclusive of value for the work described including all costs and expenses which may be required in and for the execution of the work described together with all general risks, liabilities and obligations set forth or implied in the document on which the Bid is based.

All works shall be carried out strictly as per detailed specifications whether actually specified or not. If not specified work shall be carried out as per directions of UFRMP.

The total amount entered in the Financial Bid shall be written in indelible ink and shall be entered both in figures and words.

Specifications of items of work described in BOQ for each item shall be read in conjunction with other technical specifications and specific technical requirements and quote accordingly.

2. GENERAL

The drawings of the proposed work(s) are incorporated in Bid documents. These drawings are made for Bidder's guidance and to be followed while doing the actual construction. However, Firm is free to contact UFRMP for any clarifications if required.

The Firm shall be required to submit Construction Drawings as well as General Arrangement Drawings and Structural Drawings to UFRMP and obtain prior approval to start construction if so required.

Work shall be carried out by the Firm exactly in accordance with the drawings marked as *RELEASED FOR CONSTRUCTION* and approved by UFRMP in writing.

2.1 Materials

The term "Materials" shall mean all materials, goods and articles of every kind whether raw, processed or manufactured and equipment to be supplied or to be imported by the Firm for the construction works.

Otherwise specified for particular parts of the works, the provision of clauses in "materials and workmanship" shall apply to materials and workmanship for any part of the works.

All materials shall be new and of the kinds and qualities described in the Contract and shall be approved by UFRMP.

All construction materials shall be transported, handled and stored in such a manner as to prevent deterioration, damage or contamination failing which such damaged materials will be rejected and shall not be used on any part of the works under this Contract. The Firm shall be responsible for the import of material (if any) as specified in the Bid documents, its import process, handling, transportation, installation etc.



 Chief Engineer
 Technical Cooperation Project
 Uttarakhand Forest Resource Management Project
 NTFP Centre, 49, IT Park
 Dehradun-248001

2.2 Standards

Special attention of the Firm is drawn to the relevant sections and clauses of the National Building Code of India, 1984, PWD specifications and latest BIS Codes (latest editions along with amendments) and should follow them strictly in addition to the specifications and conditions stipulated in this volume.

Materials and workmanship shall comply with the relevant Indian Standards (with amendments), unless a more recent amendment is specified hereinafter, or with the requirements of any other authoritative standard approved by UFRMP, which shall be no less exacting in the opinion of UFRMP than the corresponding standard quoted here in.

In case of any discrepancy, the decision of UFRMP will be final and binding.

2.3 Relevant Indian Standards

The following Indian Standards which are IMPORTANT and are referred to in the general specifications and used in construction works. These standards are to be strictly adhered to unless otherwise is applicable in the relevant context. These standards are to be followed both in respect of materials and construction of civil engineering works included in the Bids.

It is obligatory that only the latest edition of the standards is referred to and followed, along with all amendments and revisions issued with respect to the standard under consideration.

List of IS Specifications

Sl. No.	IS No.	Description
1	269-1976	Ordinary and low heat Portland cement
2	383-1970	Coarse and fine aggregates from natural sources for concrete
3	455-1976	Portland slag cement
4	456	Code of Practice for Plain and Reinforced Cement concrete
5	516-1959	Methods of test for the strength of concrete
6	800-1984	Code of Practice for general construction in steel
7	1199-1959	Method of sampling and analysis of concrete
8	3385	Code of Practice of measurement of civil engineering works
9	2116-1980	Sand for masonry mortars
10	2250-1981	Code of Practice for the preparation and use of masonry mortars
11	2386 (Pt.1-8)	Methods of testing for aggregate for concrete
12	2720	Methods of test for soil
13	3370 (Pt-1-4)	Code of Practice for concrete structures for storage of water
14	3764-1966	Code of Practice for excavation work
15	4082-1977	Recommendations on stacking and storage of construction material at site
16	7293-1974	Safety code for working with construction machinery
17	7969-1975	Safety code for handling and storage of building material
18	7293	Safety code for working with construction machinery
19	IRC Code	Indian Road Congress (IRC) code for road construction

2.4 General Specifications



[Signature]
 Chief Engineer
 Technical Cooperation Project
 Uttarakhand Forest Resource Management Project
 NTFP Centre, 49, IT Park
 Dehradun-248001

The Contract shall be deemed to be completed when all the works described in the specifications and set out in schedules have been successfully completed, tested and defect liability period of one year from the date of completion and handing over to the department is over.

UFRMP will establish necessary benchmarks and levels but the Firm must set out the works and he will be responsible for its correctness and it shall be incumbent on him to dismantle, remove and rebuild at his own expenses, work not correctly set out.

Further, before ordering any material, the Firm shall make his own conclusions as to the actual amount of materials as the payment will only be made on 'Net' measurement of the work actually completed.

The Firm shall provide all pegs, plates and pillars required for setting out the work as may be required by the Field UFRMP or his authorized representative in fixing benchmarks, giving levels and carrying works before, during and after execution of work.

As materials are collected and the construction of each section of the work is completed, it will be checked by UFRMP. The representative of Firm shall ascertain from UFRMP from time to time as to what part or portions he wishes to check over and passes but such approval shall in no way relieve the Firm from any of his responsibility which shall not end until the Contract has been completed.

During the progress of work and the period of maintenance, the Firm shall carry out such tests as in the opinion of UFRMP are necessary. The rates in BOQ shall include cost of such tests.

As the work proceeds, the Firm shall submit samples of materials for approval as may be required by UFRMP and all deliveries at the site shall not be below the standard of the samples. The Firm must bid in general in accordance with the requirements of these specifications.

The Firm must fill in indelible ink the rates and amount etc. in English in BOQ. He must write in words as well as in figure the rates and total cost of each item in the columns provided in BOQ. BOQ must also be signed by Firms or a duly authorized agent acting on his behalf.

The Firm must carefully go through the conditions, specifications and items of RFP and study the drawing before bidding. In case of any absurdity, he should apply to UFRMP for its rectification as no excuse for want of knowledge for non-compliance of any part or portion of these specifications or terms of Bid shall be considered at a later date at the time of actual construction.

All charges on import of materials to be supplied by the Firm for the work from outside India shall be paid by him.

In item-wise financial bid, firm prices in rupees and paisa shall be quoted for each item in the BOQ and in a manner as indicated in the Bid, Bid shall remain good and open for acceptance for a period of three months from the date they are opened.

The Firm shall, before bidding, consider all the aspects of work and shall also arrange for supply of drinking water to his own employee and labour. All such facilities as are required to be provided for the labour under the Labour Welfare Rules in force shall be provided by the Firm at his own cost.

He shall appoint sufficient number of watchmen on duty when his workers are not actually working, to safeguard work and materials. He should make his rates sufficiently comprehensive to allow for these duties. In case of accidents caused by the neglect of such precautions, Firm shall be fully responsible.

Notice boards shall be supplied and fixed in suitable positions where the road or other through fares have been opened out for the construction work, and the traffic has to be diverted or cautioned. Such board shall display in large letters in black and white or in red and white such warnings as road-closed,



[Signature]
Chief Engineer
 Technical Cooperation Project
 Uttarakhand Forest Resource Management Project
 NTFP Centre, 49, IT Park
 Dehradun - 248001

drive slow, work ahead etc.

Note: All caution boards considered or directed by UFRMP shall be provided by the Firm at his own cost as and when required and in case it is observed by UFRMP that due care in display of board not taken by the Firm, UFRMP reserves the right to set another board fixed, chargeable to the Firm.

The Firm shall include in his rates a sufficient amount to cover the cost of all temporary bridges and channel across stream or excavations at the places considered necessary by the Firm/ UFRMP. **He shall also provide for temporary diversion and reinstatement of all drains, open or covered, or water mains that may be met with during the execution of the work.**

All measurements connected with the work shall be taken geometrically or net and the dimensions given in BOQ shall be held to mean the finished size of the respective items of work.

The quantities given in BOQ are approximate and may vary. The payment will be made on actual "Net" measurements taken during construction and after completion of the works as per attached schedule. It is therefore important that the Firm should order the exact quantity of materials required after working out his own quantities, as he will not be paid for any material ordered and procured but not used on work.

The work shall be paid for in manner set out in the general conditions hereto annexed and at the rates stated in BOQ.

2.5 Materials (raw, manufactured and imported)

The Firm shall procure, provide and supply, and include in his rates, all labour, materials, tools and plants required temporarily or permanently on the works that may become proper or necessary to complete the execution of work in all respects.

The sand used on the works for cement mortar, lime mortar, cement concrete and other purpose shall comply in every respect with detailed specification No. 7 Part-I Section-DA (Buildings) of Public Works Department.

All steel required such as M.S. rounds, Angle Iron etc. will be arranged by the Firm. The steel used on works shall be of tested quality.

Certain other materials not particularly mentioned or described herein may be required for the works and these if not specifically mentioned, shall comply with the description set out in PWD detailed specification or Indian standard specifications for the respective materials. The specification in so far as they are applicable, shall be deemed to be incorporated in the Contract.

2.6 Work & workmanship

The Bidders are advised to inspect the sites at which the work is to be carried out so that they may form their own idea regarding the difficulties in transportation of materials and execution of work.

They are also advised to make their own investigations regarding the conditions of underground sub-soil conditions and strata, availability of materials and water required for construction and tests so that they may quote their rates after accounting for all the difficulties and making provisions for the complete items of works. It may be noted by the Bidder that various items of works included in BOQ required to be executed for construction of structures have to be executed with all due care so that the desired level of quality of work is achieved.

Various designs have been attached along with the Bid documents. However, UFRMP reserves the right to



Chief Engineer
 Technical Cooperation Project
 Uttarakhand Forest Resource Management Project
 NTFP Centre, 49, IT Park
 Dehradun-240001

alter or to affect minor changes without any compensation whatsoever.

Excavation for foundations of buildings and trenches for pipeline shall be carried out in accordance with PWD. The Firm shall be responsible for any damage done to any of the works in progress or partially completed due to any slips, subsidence etc. He shall make good all damages on this account at his own cost to the satisfaction of UFRMP.

Leaving aside the case when specific written orders exist, Firm in no case should use extra cement than the norms fixed for particular work, which can be had from the respective office on written request. In case if the Firm consumes extra cement, it will be treated as a wasteful expenditure and no payment will be made to Firm for such expenditure.

For all C.C. works, stone grit 10 mm to 12 mm gauge or as specified in the BoQ and clean coarse sand will be used. The mix (cement, sand and aggregate) shall be in the proportion as given in the description of items or drawings. The work shall be carried out in accordance with PWD detailed specifications. The rate of M.S. reinforcement (if any) for R.C.C. work shall include cleaning of mild steel bars of grease, dust etc., cutting to the same and fabrication to required shape and size. The reinforcement shall be measured for end-to-end and no extra payment shall be made for hook, band, overlapping and wastage. The bars shall be bent cold. The overlapping shall be to a length not less than 45 times the diameters of the bars and all bars shall be hooked at each end.

All steel used in the different works shall be of tested quality and will be arranged by the Firm. The Firm shall furnish the test certification of the steel brought by it to the site in demand and will also bear the charges for the testing of steel brought to the site if desired by UFRMP. It shall be free from pitting, loose, rust or mild scales, oil or grease, adhering earth or other materials that may adhere the bond between the concrete and the steel.

There may be certain other items of work, which though not specifically mentioned or described herein but may be required to be executed for the due completion of work under this Contract. All such works shall be carried out as per relevant PWD detailed specifications and these specifications shall be deemed to have incorporated in this Contract, read along with other clauses applicable.

This work shall be complying with PWD detailed specifications and mentioned in this specification to the satisfaction of UFRMP.

3. EARTHWORK AND EXCAVATION.

3.1 Excavation

3.1.1 Definitions

Topsoil means any surface material, including turf, suitable for use in soiling areas to be grassed or cultivated.

Excavation means excavation in open cut (excluding trench excavation) down to levels required as per approved Drawings or otherwise as being the general levels after completion of excavation.

3.1.2 Site Clearance

All area of the site, marked in the Specifications/ Drawings shall be cleared to the extent required by UFRMP of the project and obstructions of all bushes, hedges, trees, stumps, roots and other vegetation except for trees marked for preservation. Material so cleared shall so far as suitable be preserved and stacked, and will be the property of UFRMP/ UKFD.



[Signature]
 Chief Engineer
 Technical Cooperation Project
 Uttarakhand Forest Resource Management Project
 NTFP Centre, 49, IT Park
 Dehradun-248001

Before starting the work, the site shall be cleared of all shrubs, grasses and other vegetation including large and small bushes, all stumps, removal of roots, cutting and disposal of small trees up to 300 mm girth etc.

All trees having girth above 300 mm (the girth shall be measured at a height of 1.5 m above the ground level) by felling, logging, fashioning of timber and billeting of all branches, trunks etc. including removal of all roots etc. complete as directed.

All serviceable reclaimed material shall be stacked separately near the site of excavation and/ or transported as directed by UFRMP.

After the tree is cut and roots taken out, the potholes formed shall be filled with good earth in 250 mm layers and consolidated unless directed by UFRMP otherwise. The trees shall be cut in suitable piece as instructed by UFRMP.

3.1.3 General Excavation

General excavation means excavation required for structures and from borrows areas. General excavation may also include miscellaneous isolated lengths of trenches beneath or adjacent to other structures, along the structural layout or otherwise.

The ground shall be excavated by such methods and to such dimensions and depths as shall allow for the proper construction of the works and safety of personnel and equipment used on excavation. Slopes required for stable formation of sides shall be provided.

The excavation in earth, boulders, soft and hard rock shall be carried out to the correct levels required and specified and no tolerance, plus or minus, shall be permitted. However, if any depressions/ loose pockets are formed due to removal of boulders, they shall be made good by filling. Payment for all types of excavation shall be made by detailed measurement supported by ground levels recorded prior to and after completion of excavation, subject to the limit for payment indicated by the slopes of excavation indicated in the specification drawing. Any additional excavation will be at the Firm's expense, unless specifically approved by UFRMP. Measurement for excavation shall be done as per dimensions given in design drawings & specifications. For concrete foundations same shall be paid on least dimensions at bottom and Firm shall cover any extra excavation required for workspace, supports etc. while quoting.

As far as possible excavation should be done by means of mechanical equipment. The Bidder should quote accordingly and no additional payment will be done for mechanical excavation and deployment of extra staff.

It will be the responsibility of the Firm to obtain prior permissions from the competent authority to use blasting device, if at all to be resorted to and the licenses are to be obtained for the same.

The chance of blasting if required shall be well decided by the expert, to avoid any damage to the surrounding property. However, for any such damage to the surrounding property or public or additional excavation shall be the Firm's responsibility and the risks whatsoever arising from the same will have to be borne by the Firm.

3.1.4 Lead

Lead for deposition of the excavated materials should be at appropriate places. For the purpose of measurement of lead, the area to be excavated or filled or area in which excavated material is to be deposited /disposed off shall be divided into suitable blocks and for each of the blocks, the distance between centerlines shall be taken as the lead which shall be measured by the shortest straight-line



Chief Engineer
 Technical Cooperation Project
 Uttarakhand Forest Resource Management Project
 NTFP Centre, 49, IT Park
 Dehradun-248001

route on plan and not the actual route taken by Firm. No extra compensation is admissible on the grounds that the lead including that for borrowed material had to be transported over marshy or kaccha land route.

3.1.5 Excavation in Hard Rock

Excavation in hard rock may be done either by blasting or chiseling depending upon the site conditions. When excavation has reached within 300 mm of the required formation level, further excavation shall be carried out carefully either by blasting (if as directed) or chiseling. Where blasting is resorted to, small charges shall be used to minimize occurrence of heavy over-cuts. The Firm shall make every effort to carry out the excavation to correct formation level as far as practicable. In order to minimize the over break and loosening of materials at the finished surfaces, final cutting for the last 450 mm to 600 mm in rock shall be carried out by controlled blasting and trimming with the help of pneumatic or other power tools. Unless otherwise specified, the over break shall not exceed 75 mm. The over breakage of 75 mm shall not be measured for payment and therefore the Firm while quoting his rates for rock excavation has to take this into account. Deduction of 40% or higher percentage as may be decided by UFRMP shall be made to allow for the voids. Stacks shall not be of width greater than 1.5 m wide or of height less than one meter

Blasting (if required) shall be carried out by the licensed person. The Firm shall provide a method statement and shall comply fully with the requirements of this clause, or any direction, order, requirement or instruction given by the police department or any other relevant authorities as required by the law.

Firm shall plan the blasting activities (if required) well in advance and convey same to UFRMP so as to co-ordinate with all the concerned at site.

It should be noted that this clause does not override the Firm's obligation to satisfy the requirement of the relevant authorities but sets out the extent to which UFRMP will exercise his control in approving the Firm's use of explosive to ensure that explosives are always used in a safe manner. It is the Firm's sole responsibility to ensure that his method of blasting is safe, that all statutory and imposed limitation are adhered to, and to obtain a permit to use explosive from the relevant authorities and to comply with the condition of issue of the permit.

The Firm shall be solely responsible for obtaining the necessary licenses for the procurement, possession, transport, storage and handling of explosive and for ensuring the validity of such licenses at all times. Before starting work, the Firm shall satisfy UFRMP that all the requirement permits are in order and that this category of work is adequately covered in the policies of insurance.

Explosives shall be used in the quantities and manner recommended by the manufacturers duly approved by UFRMP.

All necessary precautions shall be taken to preserve the materials below in the soundest possible condition and also beyond the lines of all excavations.

Blasting by means of drill holes, tunnels or any other similar method shall be the responsibility of the Firm.

The Firm shall take all necessary precautions during blasting operations to ensure that no injure is caused to persons or damage to property or to the finished works. Shots shall be properly loaded and capped and only appropriate charges shall be used in each hole.



 Chief Engineer
 Technical Cooperation Project
 Uttarakhand Forest Resource Management Project
 NTFP Centre, 49, IT Park
 Dehradun-248001

3.1.6 Storage and Transport

Proper building or magazine, with separate compartment for detonators in suitable positions for the storage of explosive in the manner and quantities to be approved, shall be provided. Separate vehicles or vessels for detonators shall also be used for the transportation of explosives. The prevention of any unauthorized issue or improper use of any explosive brought on to the site shall be the responsibility of the Firm and only experienced licensed short firers shall be employed to handle the explosive for the purpose of the work the relevant security regulations dealing with the storage, handling and transport of explosives shall be complied with.

3.1.7 Safety

The Firm shall provide an approved system of warning and preparing the general public and all site personnel of an impending blast by both audible & visual means and shall ensure that the blasting area is cleared of all personnel immediately prior to blasting. This system shall comply with all statutory requirements. The Firm's attention is drawn to the need to devise adequate system for warning and clearing the public from specified areas during blasting operations and to prevent persons entering the blasting area.

When blasting is near to the proximity of existing public and private thoroughfares, traffics to be stopped just prior to firing. The operation is to be carried out in close cooperation with the police department and in such a way as to cause minimum traffic delay.

All operations involving explosives shall be suspended on the approach of a thunderstorm and shall not be resumed until the storm has clearly passed.

Blasting screens shall be erected to conform with the permit conditions. Public roads, private roads and property adjacent to the site and services within the site area shall be protected by rock fall fences which will be subjected to UFRMP's approval.

The Firm shall take all necessary precautions to avoid damage to permanent and temporary works already completed. In all cases, delay blasting techniques will be mandatory with the quantity of explosives restricted to ensure that the peak particle velocity generated does not exceed the peak particle velocity of each component of the safe limits of the nearest structure subject to vibration damage. All operations shall stop when these limits are exceeded until reports are made available to UFRMP that no damage has occurred and will not occur or corrective action has been taken to lower the vibration. The sound level limit in areas where site personnel or public can access during blasting operation must not exceed 110dB.

Drilling rigs for shot hole shall be of the hydraulic type fitted with efficient silencers and with means of dust separation.

The Firm may report to any of the following methods to excavate rock by chiseling:

- i) Wedging by means of crowbars, pick axes or pneumatic drills
- ii) Heating and quenching
- iii) Controlled blasting with a small charge just sufficient to make a crack in rock which will be subsequently removed by wedging

No extra payment shall be made for removal of rock by chiseling and controlled blasting.



J. S. Sharma
 Chief Engineer
 Technical Cooperation Project
 Uttarakhand Forest Resource Management Project
 NTFP Centre, 49, IT Park
 Dehradun-248001

3.1.8 Excess excavation to be made good

The Firm, at his own expense, shall, if directed, remove from the Site all excess material resulting from excess excavation and shall make good the same with such kind of fill material or in such class of concrete as may be reasonably required by UFRMP having regard to the circumstances.

3.1.9 Supporting Excavations

The Firm shall properly support the sides and ends of all excavations to prevent any fall or run from any portion of the ground outside the excavation and to prevent settlement or damage to structures adjacent to the excavation. Any excavation necessary to provide space for such support or other working space shall be carried out. If, for any reason, any portion of the bottoms, sides or ends of any excavations shall give way, the Firm shall at his own expense take all necessary remedial measures including the extra necessary excavation and removal of excess material.

Where the Firm proposes and is permitted by UFRMP to perform excavations with sloping faces (other than sloping excavations shown on the Drawings or required as permanent features of the Works) and without shoring, the excavated faces shall be to treated / protected for stable slopes and heights.

3.1.10 Trimming Excavations

When excavating to specified or required levels for the foundation of any structure or to specified or required limits for the face of any structure required to about undisturbed ground, the Firm shall not excavate the last 150 mm until immediately before commencing the constructional work, except where UFRMP shall permit otherwise. After getting the permission for the commencement of the construction, if the Firm delays on any account & the formation level gets damaged, he will have to do further excavation up to 150mm or as per UFRMP's instructions at his own account.

Before commencement of any constructional work all shattered and loose materials shall be removed from the excavations by hand so as to ensure that the work rests on a solid and perfectly clean foundation or abuts against solid ground.

3.1.11 Inspection by UFRMP

When the specified levels or limits of excavation are reached UFRMP will inspect the ground exposed, and if he considers that any part of the ground is by its nature unsuitable he may direct the Firm to excavate further. Such further excavation shall be refilled to the specified levels or limits with concrete, selected excavated material or selected imported material as directed by UFRMP.

Should the material forming the bottom of any excavation, while acceptable to UFRMP at the time of his inspection, subsequently become unacceptable to him due to exposure to weather conditions or due to flooding or have puddles, soft or loss during the progress of the works, the Firm shall remove such damaged, softened or loosened material and excavate without any extra cost.

3.1.12 Disposing Excavated Material

All excavated material shall remain the property of UFRMP. The Firm shall ensure that no excavated material which is suitable for and is required for re-use in the Works is transported unless so ordered by UFRMP.



Chief Engineer
 Technical Cooperation Project
 Uttarakhand Forest Resource Management Project
 NTFP Centre, 49, IT Park
 Dehradun-248001

3.2 Back-Filling General Site Grading and Sand Filling

3.2.1 Fill Material

All fill material whether such material is brought from outside borrow areas or excavation within the site, will be subject to UFRMP's approval after carrying required tests at Firm's Soil testing laboratory. Notwithstanding any approval given to the fill material or borrow areas from which fill material is proposed to be brought, UFRMP reserves the right to reject such material which does not meet the specification requirements or unsuitable for the purpose for which it is intended.

3.2.2 Backfilling

Excavated material used as back filling to excavations or completed structures shall be free from rubbish, vegetation, clods and lumps and shall be approved by UFRMP. The approved materials shall be placed in layers, not exceeding 150 mm in depth before compaction and shall be compacted with watering, consolidating and ramming. The maximum boulder size shall be of 150 mm for filling material

Soft material shall not be used as back filling around structures in rock. The Firm shall backfill such excess excavation with concrete; rubble, stone or rock fills as directed by UFRMP. Filling other than concrete shall be placed in layers not exceeding 150 mm in thickness, shall be thoroughly compacted and have adequate fined content to fill the voids.

Should the material being placed as back filling, while acceptable at time of selection, become unacceptable to UFRMP due to exposure to weather conditions or due to flooding or have become puddles, soft or segregated during the progress of works, the Firm shall remove such damaged, softened or segregated material and replace it with fresh approved material at his expense.

The Firm shall while placing the back filling make due allowance for any settlement that may occur before the end of the Defects Liability Period, remove any excess material or make up any deficiency by back filling to the specified levels. As a rule, material to be back filled shall be stacked temporarily at a suitable place.

General Site Grading: Site grading shall be carried out as directed by UFRMP. Excavation shall be carried out as specified in the specification. Filling and compaction shall be carried out as specified under (6) of this Clause unless otherwise indicated below.

The approved material shall be placed in layers not exceeding 150 mm in depth before compaction and shall be compacted to 90% of Proctor Density with water content at OMC. The Firm shall protect the earth fill from being washed away by rain or damaged in any other way. Should any slip occur, the Firm shall remove the affected materials and make good the slip without any extra cost.

The fill shall be carried out to such dimensions and levels as directed by UFRMP, after the compaction.

3.2.3 Sand filling

Back filling shall be carried out with sand at places as directed by UFRMP. The sand used shall be clean, medium grained and free from impurities. The filled-in-sand shall be kept flooded with water for 24 hours to ensure maximum consolidation. Any temporary work required to contain sand under flooded conditions shall be to the Firm's account. The surface of the Consolidated sand shall be dressed to the required level or slope. Construction of structures on sand fill (if so done) shall not be started until UFRMP has inspected and approved the fill.

Where specified in the schedule of works, compaction of the plinth fill shall be carried out by means



J. Sharma
Chief Engineer
 Technical Cooperation Project
 Uttarakhand Forest Resource Management Project
 NTFP Centre, 49, IT Park
 Dehradun-248001

of 12 tons rollers smooth wheeled, sheep foot or wobbly-wheeled rollers. A smaller weight roller may be used only if permitted by UFRMP. As rolling proceeds water sprinkling shall be done to assist consolidation. Water shall not be sprinkled in case of sandy fill.

The thickness of each unconsolidated fill layer can in this case up to 300 mm. UFRMP will determine the thickness of layers in which fill has to be consolidated depending on the fill material and equipment used.

Rolling shall commence from outer edge and progress towards the center and continue until compaction is to the satisfaction of UFRMP, but in no case less than 10 passes of the roller will be accepted for each layer.

The compacted surface shall be properly shaped, trimmed and consolidated to an even and uniform gradient. All soft spots shall be excavated and filled and consolidated.

At some locations/ areas it may not be possible to use rollers because of space restrictions etc. Firm shall then be permitted to use pneumatic tampers, rammers etc. and he shall ensure proper compaction.

3.2.4 Fill Density

The compaction, only where so called for, in the schedule of quantities/items shall comply with the specified (proctor/modified proctor) density at moisture content differing not more than 4 percent from optimum moisture content. Firm shall demonstrate adequately at his cost, by field and laboratory tests that the specified density had been obtained.

3.2.5 Local Rules and Regulations

The Firm shall familiarize himself with the local rules and regulations governing the excavation, quarrying operations, etc. and the work shall be carried out strictly in accordance with rules and regulations, if any. Whenever a quarry is required to be opened in connection with the execution of work covered under this Contract, the Firm shall investigate that it shall yield stones and other materials such as sand, murum, soil etc. of approved quality and shall satisfy himself as to the availability in desired quantity. He shall supply necessary quantity of sand, stone, metal aggregate etc. to UFRMP for carrying out tests as desired by UFRMP and well in advance of its use so as to carry out tests and to get approval. The cost of opening and operating the quarry & royalties and ant other charges shall be borne entirely by the Firm.

The Firm shall obtain necessary permission from the concerned authorities before opening the quarry. In case of quarries in private land on payment of whatever charges as may be due to the owner.

3.3 DEWATERING

All excavations shall be kept free of water. Grading in the vicinity of excavations shall be controlled to prevent surface water running into excavated areas. The Firm shall remove by pumping or other means approved by UFRMP any water inclusive of rainwater and sub-soil water accumulated in excavation and keep all excavations de-watered until the foundation work is completed and back filled. Sumps made for dewatering must be kept clear of the excavations/trenches required for further work. Method of pumping shall be approved by UFRMP; but in any case, the pumping arrangement shall be such that there shall be no movement of sub-soil or blowing in due to differential head of water during pumping. Pumping arrangements shall be adequate to ensure no delays in construction.



J. S. Sharma
Chief Engineer
 Technical Cooperation Project
 Uttarakhand Forest Resource Management Project
 NTFP Centre, 49, IT Park
 Dehradun-248001

3.4 RAIN WATER DISCHARGE

The scope covers the drainage of the rainwater in excavated areas.

Grading in the vicinity of excavation shall be such as to exclude rain/surface water draining into excavated areas. Excavation shall be kept clean of rain and such water as the Firm may be using for his work by suitably pumping out the same at no extra cost to the Owner. The scheme for pumping and discharge of such water shall be approved by UFRMP.

3.5 TIMBER SHORING

The Timber Shoring shall be as per 3764-1966 safety code for excavation work. Close timbering shall be done by completely covering the sides of the trenches and pits generally with short, upright members called 'polling board'. The boards shall generally be placed in position vertically side by side without any gap on each side of the Excavation and shall be secured by horizontal walling of strong wood at maximum 1.2 m spacing and suitably strutted. If the soil is very soft and loose, the boards shall be placed horizontally against each side of the excavation and supported by vertical walling, which in turn shall be suitably strutted. The lowest boards supporting the sides shall be taken into the ground and no portion of the vertical side of the trench or pit shall remain exposed, so as to render the earth liable to slip out. The shoring material shall not be sizes less than those specified below unless steel sheet piling is used or unless otherwise approved by UFRMP in writing:

Planks	-	5 cm x 25 cm
Waling pieces	-	10 cm x 20 cm
Struts	-	15 cm x 20cm

Timber shoring shall be 'close' or 'open' type, depending on the nature of soil and the depth of pit or trench. The type of timbering shall be as approved by UFRMP. It shall be the responsibility of the Firm to take all necessary steps to prevent the sides of excavations, trenches, pits, etc., from collapsing.

Timber shoring may be required to keep the sides of excavations vertical to ensure safety of adjoining structures or to limit the slope of excavations, or due to space restrictions or for other reasons. Such shoring shall be carried out, except in an emergency, only under instructions from UFRMP.

The withdrawal of the timber shall be done very carefully to prevent the collapse of the pit or trench. It shall be started at one end and proceeded systematically to the other end. Concrete or masonry shall not be damaged during the removal of the timber. No claim shall be entertained for any timber, which cannot be retrieved.

In the case of open timbering, the entire surface of the side of trench or pit is not required to be covered. The vertical boards of minimum 25 cm X 5 cm sections shall be spaced sufficiently apart to leave unsupported strips of maximum 50 cm average width. The detailed arrangement, sizes of the timber and the spacing shall be subject to the approval of UFRMP. In all other respects, the specification for close timbering shall apply to open timbering. In case of large pits and open excavations, where shoring is required for securing safety of adjoining structures or for any other reasons and where the planking across sides of excavations/pits cannot be strutted against, suitable inclined struts supported on the excavated bed shall be provided. Load from such struts shall be suitably distributed on the bed to ensure no yielding of the strut.



J. K. Sharma

Chief Engineer
 Technical Cooperation Project
 Uttarakhand Forest Resource Management Project
 NTFP Centre, 49, IT Park
 Dehradun-248001

4. CONCRETE AND ALLIED WORKS

4.1 General

The quality of materials and method and control of manufacture and transportation of all concrete work irrespective of mix, whether reinforced or otherwise shall conform to the applicable portions of this specification.

UFRMP shall have the right to inspect the source/s of material/s, the layout and operation of procurement and storage of materials, the concrete batching and mixing equipment, and the quality control system. Such an inspection shall be arranged and UFRMP's approval obtained, prior to starting of concrete work. However, this shall not relieve the Firm with any of his responsibilities and all the materials, which do not conform to the specifications, will be rejected.

4.2 Applicable Codes

The following specifications, standards and codes, including all official amendments/revisions and other specifications & codes referred to therein to therein, should be considered a part of this specification. In all cases the latest issue/edition/revision shall apply. In case of discrepancy between this specification and those referred to herein this bid document, this specification shall govern.

Materials Storage

IS:4082 - Recommendations on stacking and storing of construction materials at site.

Concrete Mix Design

IS:10262 - Recommended guidelines for concrete mix design. SP:23 - Handbook on Concrete Mixes. (S &T)

Concrete Testing

IS:1199 - Method of sampling and analysis of concrete.
 IS:516 - Method of test for strength of concrete
 IS:9013 - Method of making, curing and determining compressive strength of accelerated cured concrete test specimens.
 IS:8142 - Method of test for determining setting time of concrete by penetration resistance.
 IS:9284 - Method of test for abrasion resistance of concrete. IS:2770 - Methods of testing bond in reinforced concrete.

Codes of Practice

IS:456 - Code of practice for plain and reinforced concrete.
 IS:457 - Code of practice for general construction of plain and reinforced concrete for dams and other massive structures.
 IS:3370 - Code of practice for concrete structures for storage of liquids (parts-I to IV)
 IS:3935 - Code of practice for composite construction.
 IS:2502 - Code of practice for bending and fixing of bars for concrete reinforcement.
 IS:5525 - Recommendation for detailing of reinforcement in reinforced concrete works
 IS:2751 - Code of practice for welding of mild steel plain and deformed bars used for reinforced concrete construction
 IS:9417 - Specification for welding cold worked bars for reinforced concrete construction
 IS:13920 - Ductile Detailing of Reinforced Concrete Structure subjected to



Chief Engineer
Technical Cooperation Project
Uttarakhand Forest Resource Management Project
NTFP Centre, 49, IT Park
Dehradun-248001

		1993 seismic forces
SP-16	-	Design Aids for Reinforcement Concrete to IS:456-1978 (S&T)- 1980
SP-24	-	Explanatory Handbook on IS:456-1978
SP-34	-	Handbook on Concrete Reinforcement and Detailing (S&T)- 1987

Construction Safety

IS:3696	-	Safety code for scaffolds and ladders (Parts-I & II)
IS:7969	-	Safety code for handling and storage of building materials IS:8989
		Safety code for erection of concrete framed structures

Measurement

IS: 1200		Code of practice for measurement of civil Engineering works
----------	--	---

4.3 Materials for Standard Concrete

The ingredients to be used in the manufacture of concrete shall consist solely of Ordinary Portland Cement or Sulphate Resistant Cement clean sand, natural coarse aggregate, clean water, and admixtures.

The Firm will have to make own arrangements for procuring cement and steel. Cement remaining in bulk storage at the mill, prior to shipment for more than 6 months or cement in bags in local storage in the hands of vendor for more than 3 months after completion of tests may be retested before use and may be rejected if it fails to conform to any of the requirement of IS 269-1976.

The Firm will have to make his own arrangements for transport from supplier godown and storage of adequate quantity of cement. Firm will construct cement godown in batches of 10x10, which will provide complete protection from dampness, contamination and minimize caking and false set. Cement bags shall be stored in a dry enclosed shed (storage under tarpaulins will not be permitted), well away from the outer walls and insulated from the floor to avoid contact with moisture from the ground and so arranged as to provide ready access. Damaged or reclaimed or partly set cement will not be permitted to be used and shall be removed from the site. The storage bins and storage arrangement shall be approved by UFRMP. Consignments of cement shall be stored as received and shall be consumed in the order of their delivery. Stacking of cement shall be done as per IS and in such a way that first come cement shall be used first.

Cement held in storage for a period of ninety (90) days or longer shall be tested. Should at any time UFRMP has reasons to consider that any cement is defective, then irrespective of its origin, date of manufacture and or manufacturer's test certificate, such cement shall be tested immediately at the Firm's cost at an approved laboratory and until the results of such tests are found satisfactory, it shall not be used in any work. Testing certificates for each batch of cement should be submitted by the Firm to UFRMP, before starting the work. The Firm shall not be entitled to any claim of any nature on this account.

4.3.1 Aggregates

i) General

"Aggregate" in general designates both fine and coarse inert materials used in the manufacture of concrete (Vide BIS 456 & BIS 383) and confirming to tests as per BIS 2386 (Part I to VI). "Coarse Aggregate" is aggregate most of which is retained when passed through on 4.75 mm BIS sieve.

Aggregates shall consist of natural sands, stone (crushed or uncrushed) and gravel from a source known to produce satisfactory aggregate for concrete and shall be chemically inert, non-flaky, strong,



Chief Engineer
Technical Cooperation Project
Uttarakhand Forest Resource Management Project
NTFP Centre, 49, IT Park
Dehradun-248001

hard, durable against weathering, of limited porosity and free from deleterious materials that may cause corrosion of the reinforcement or may impair the strength and or durability of concrete. The grading of aggregates shall be such as a dense concrete of specified strength and consistency that will work readily into position without segregation and shall be based on the "mix design" and preliminary tests on concrete specified later.

ii) Storage of aggregates

All coarse and fine aggregates shall be stacked separately in stock piles in the material yard near the work site in bins properly constructed to avoid inter mixing of different aggregates. Contamination with foreign material and earth during storage and while heaping the materials shall be avoided. The aggregates must be of specified quality not only at the time of receiving at site but more so at the time of loading into mixer. Rakes shall be piled in layers not exceeding 1.20 m in height to prevent coning or segregation. Each layer shall cover the entire area of stockpile before succeeding layers are started. Aggregates that have become segregated shall be rejected.

iii) Specific Gravity

Aggregates having a specific gravity below 2.4 (saturated surface dry basis) shall not be used.

4.3.2 Fine Aggregate

- a) Fine aggregate shall consist of natural or crushed sand conforming to BIS 383 conforming to tests as per BIS 2386 part I to VI. The sand shall be clean, sharp, hard, strong and durable and shall be free from dust, vegetable substances, adherent coating, clay, alkali, organic matter, mica, salt, or other deleterious substances, which can be injurious to the setting qualities/strength/durability of concrete.
- b) Screening and Washing: Sand shall be prepared for use by such screening or washing, or both, as necessary, to remove all objectionable foreign matter while separating the sand grains to the required size fraction.
- c) Foreign Material limitations: The percentage deleterious substances in sand delivered to the mixer shall not exceed the following:

Foreign Material Limitations in Fine Aggregate

Sr. No.	Foreign material	Percentage by weight	
		Uncrushed	Crushed
1	Material finer than 75-micron BIS sieve	3.0	15.0
2	Shale	1.0	
3	Coal & Lignite	1.0	1.0
4	Clay Lumps	-	1.0
	Total	5.0	17.0

- d) Gradation: Unless otherwise directed or approved by UFRMP, the grading of sand shall be within the limits indicated hereunder:

e)



[Signature]
Chief Engineer
 Technical Cooperation Project
 Uttarakhand Forest Resource Management Project
 NTFP Centre, 49, IT Park
 Dehradun-248001

Grading of Sand for Fine Aggregate

BIS: Sieve Designation	Grading Zone I	Grading Zone II	Grading Zone III	Grading Zone IV
10 mm	100	100	100	100
4.75 mm	99-100	90-100	90-100	95-100
2.36 mm	60-95	75-100	85-100	95-100
1.18 mm	30-70	55-90	75-100	90-100
600 microns	15-34	35-59	60-79	80-100
300 microns	5-20	8-30	12-40	15-50
150 microns	0-10	0-10	0-10	0-15

Where the grading falls outside the limits of any particular grading zone of sieves, other than 600 microns IS sieve, by total amount not exceeding 5%, it shall be regarded as falling within that grading zone. This tolerance shall not be applied to percentage passing the 600 micron IS sieve or to percentage passing any other sieve on the coarser limit of grading zone I or the finer limit of grading zone IV. Fine aggregates conforming to grading zone IV shall be used. Mix designs and preliminary tests shall show its suitability for producing concrete of specified strength and workability.

f) Fineness Modulus

The sand shall have a fineness modulus of not less than 2.0 or more than 3.5. The fineness modulus is determined by adding the cumulative percentages retained on the following IS sieve sizes (4.75 mm, 2.36 mm, 1.18 mm, 600 microns and 150 microns) and dividing the sum by 100.

4.3.3 Coarse Aggregate

Coarse aggregate for concrete, except as noted above, shall conform to IS 383 & IS 2386. This shall consist of crushed stone and shall be clean and free from elongated, flaky or laminated pieces, adhering coatings, clay lumps, coal residue, clinkers, slag, alkali, mica, organic matter or other deleterious matter.

Screening and Washing: Crushed rock shall be screened and/or washed for the removal of dirt or dust coating, if so requested by UFRMP.

Grading

- i) Coarse aggregate shall be either in single size or graded, in both cases the grading shall be within the following limits as in the table below. The pieces shall be angular in shape and shall have granular or crystalline surfaces. Friable, laky and laminated pieces, mica and shale, if present, shall be only within tolerance limits which will not affect adversely the strength and or durability of concrete. The maximum size of coarse aggregate shall be 40 mm for M-7.5 and M-10 and 20mm for M-15 to M-30 concrete, or as directed by UFRMP or specified. The maximum size of coarse aggregate shall be the maximum size specified above but in no case greater than 1/4th of the minimum thickness of the member, provided that the concrete can be placed without difficulty so as to surround all reinforcement thoroughly and fill the corners of the form. For plain concrete the maximum size of aggregate shall be of 40 mm. For heavily reinforced concrete members, the nominal maximum size of the aggregate shall be 5 mm less than the minimum clear distance between the reinforcing main bars or 5 mm less than the minimum cover to reinforcement whichever is smaller.



J. Sharma
Chief Engineer
 Technical Cooperation Project
 Uttarakhand Forest Resource Management Project
 NTFP Centre, 49, IT Park
 Dehradun-248001

BIS Sieve Size(mm)	Percentage passing for single sized aggregate of normal size					Percentage Passing for Graded Aggregate Of Normal Size			
	40 mm	20 mm	16 mm	12.5mm	10mm	40 mm	20 mm	16 mm	12.5mm
63	100	-	-	-	-	100	-	-	-
40	85-100	100	-	-	-	95-100	-	-	-
20	0-20	85-100	100	-	-	30-70	95-100	100	-
16	-	-	85-100	100	-	-	-	90-100	-
12.5	-	-	-	85-100	100	-	-	-	90-100.
10	0-5	0-20	0-30	0-45	85-100	10-35	25-35	30-70	40-85.
4.75	-	0-5	0-5	0-10	0-20	0-5	0-10	0-10	0-10.
2.36					0-5				

Foreign material limitations

The percentage of deleterious materials in the aggregate delivered to the mixer shall not exceed the following:

Foreign Material Limitations in Coarse Aggregate

Sr.No.	Foreign Material	Percentage by Weight	
		Uncrushed	Crushed
1	Material finer than 75-micron BIS Sieve	3.0	3.0
2	Coal and lignite	1.0	1.0
3	Clay Lumps	1.0	1.0
4	Soft Fragments	3.0	-
	Total	8.0	5.0

4.3.4 Water

Water used for washing, mixing and curing shall be free from injurious amounts of deleterious materials. Potable water is generally satisfactory for mixing and curing concrete. Physical and chemical analysis of the water should be submitted to UFRMP, before starting the work.

In case of doubt, the suitability of water for making concrete shall be ascertained by the compressive strength and initial setting time test specified in BIS 456. The sample of water taken for testing shall be typical of the water proposed to be used for concreting, due account being paid to seasonal variation. The sample shall not receive any treatment before testing other than that envisaged in the regular supply of water proposed for use in concrete. The sample shall be stored in a clean container previously rinsed out with similar water.

Average 28 days compressive strength of at least three 15 cm concrete cubes prepared with water proposed to be used shall not be less than 90% of the average strength of three similar concrete cubes



Chief Engineer
 Technical Cooperation Project
 Uttarakhand Forest Resource Management Project
 NTFP Centre, 49, IT Park
 Dehradun-248001

prepared with distilled water. The cubes shall be prepared, cured and tested in accordance with the requirements of BIS 516. The initial setting time of test block must be made with the appropriate test cement and the water proposed to be used. It shall not be less than 30 minutes and shall not differ by more than +/-30 minutes from the initial setting time of control test block prepared with the appropriate test cement and distilled water. The test block shall be prepared and tested in accordance with the requirements of BIS 4031.

Where water can be shown to contain an excess of acid, alkali, sugar or salt, UFRMP may refuse to permit its use. As a guide, the following concentrations represent the maximum permissible values.

To neutralize 200 ml sample of water, using phenolphthalein as indicator, it should not require more than 2 ml of 0.1 normal NaOH. The details of test shall be as given in BIS 3025.

To neutralize 200 ml sample of water, using methyl orange as an indicator, it should not require more than 10 ml of 0.1 Normal HCl. The details of test shall be as given in BIS 3025.

Percentage of solids, when tested in accordance with the method indicated below shall not exceed the following:

Solids	Percent	Method of test
Ref. to col. no in IS:3025) Organic		
(organic solid = total solids minus ignited residue)	0.02	10 and 11
Inorganic	0.03	11(ignited residue)
Sulphates (as SO_4)	0.05	20
Alkali Chlorides (as Cl)	0.20	24
Suspended matter	0.20	12

4.3.5 Anchor Bolts, Anchors, Sleeves, Inserts, Hangers/Conduits/Pipe and Other Misc. Embedded Fixtures

The Firm shall build into concrete work all the items mentioned in Drawings and shall embed them partly or fully as directed and secure the same as may be required. The materials if required to be supplied by the Firm, shall be as specified and be of best quality available according to relevant Indian standards of approved manufacture and to the satisfaction of UFRMP. Exposed surface of embedded materials is to be painted with one coat of approved anti-corrosive paint and/ or bituminous paint without any extra cost to the owner. If welding is to be done subsequently on the exposed surface of embedded material the paint shall be cleaned off the member to a minimum length of 50 mm beyond each side of the weld line.

Necessary templates, jigs, fixtures, supports etc. shall be used as may be required or directed by UFRMP.

4.3.6 Controlled Concrete

All concrete in the works shall be "Controlled Concrete" as defined in IS: 456 except for M-7.5 and M-10 for which normal mix concrete shall be used. Whether reinforced or otherwise, all concrete works to be carried out under this specification shall be divided into the following classifications:



Chief Engineer
 Technical Cooperation Project
 Uttarakhand Forest Resource Management Project
 NTFP Centre, 49, IT Park
 Dehradun-248001

Minimum Compressive Strength of 15 cm cubes at 7 days and 28 days after mixing, conducted in accordance with IS: 516.

Any operation of concrete done at atmospheric temperature above 40°C or where the temperature of concrete at the time of placement is expected to be beyond 40°C may be categorized as hot weather concreting and should be confined to the requirement of IS 7861(Part-I) 1975 and SP-23 (S&T)-1982.

Class	Preliminary Test N/mm ²		Works Test N/mm ²		Max. Size of Aggregate (mm)
	At 7 Days	At 28 days	At 7 days	At 28 days	
M25	22.0	32.0	17.0	25.0	40 or 20
M20	17.5	26.0	13.5	20.0	40 or 20

Note: It shall be very clearly understood that whenever the grade of concrete such as M-20, etc. is specified it shall be Firm's responsibility to ensure the minimum crushing strength stipulated for the respective grade of concrete is obtained at works.

4.4 Mix Design

4.4.1 General

This is essential for investigating the grading of aggregates, water-cement ratio, workability and the quality of cement required to give preliminary and works cubes of the minimum strength specified. The proportions of the mix shall be determined by weight. Adjustment of aggregate proportions due to moisture present in the aggregate shall be made. Determination of mix proportions shall be carried out according to "Recommended guidelines for Concrete Mix Design" conforming to IS:10262.

Whenever there is a change either in required strength of concrete, or water-cement ratio or workability or the source of aggregates and/or cement, preliminary tests shall be repeated to determine the revised proportions of the mix to suit the altered conditions. While designing proportions, over-wet mixes shall always be avoided.

While fixing the value for water/cement ratio for preliminary mixes, assistance may be derived from the graph (Appendix A, BIS 456 showing the relationship between the 28-day compressive strengths of concrete mixes with different water/cement ratios and the 7-day compressive strength of cement tested in accordance with IS: 269.

4.4.2 Preliminary Tests

Test specimens shall be prepared with at-least two different water/cement ratios for each class of concrete, consistent with workability required for the nature of the work. The materials and proportions used in making preliminary tests shall be similar in all respects to those to be actually employed in the works as the object of these tests is to determine the properties of cement, aggregates and water necessary to produce concrete of required consistency and to give the specified strength, it will be Firm's sole responsibility to carry out these tests and he shall therefore furnish to UFRMP a statement of proportions proposed to be used for the various concrete mixes. For preliminary tests, the following procedure shall be followed.

Materials shall be brought to the room temperature and all materials shall be in a dry condition. The quantities of water cement and aggregates for each batch shall be determined by weight to an



Chief Engineer
 Technical Cooperation Project
 Uttarakhand Forest Resource Management Project
 NTFP Centre, 49, IT Park
 Dehradun-248001

accuracy of 1 part in 100parts.

Mixing concrete shall be done by hand (for small quantities, as directed by UFRMP) or in a small batch mixer as per IS: 516 in such a manner as to avoid loss of water. The cement and fine aggregate shall first be mixed dry until the mixture is uniform in color. The coarse aggregate shall then be added, mixed and water added and the whole batch mixed thoroughly for a period of not less than two minutes until the resulting concrete is uniform in appearance. Each batch of concrete shall be such a size as to leave about 10% excess concrete, after moulding the desired number of test specimens.

The consistency of each batch of concrete shall be measured immediately after mixing, by the slump test in accordance with IS: 1199. If in the slump test, care is taken to ensure that no water or other material is lost, the material used for the slump test may be re-mixed with the remainder of the concrete for making the specimen test cubes. The period of re-mixing shall be as short as possible yet sufficient to produce a homogeneous mass.

The samples for compression tests of concrete shall be made as per IS: 516 on 15 cm cubes. Each mould shall be provided with a metal base plate having a plate surface so as to support the mould during filling without leakage. The base plate shall be preferably attached to the mould by springs or screws. The parts of the mould when assembled shall be positively and rigidly held together. Before placing concrete, the mould and base plate shall be cleaned and oiled. The dimensions and internal faces of the mould shall be accurate within the following limits. Height and distance between the opposite faces of the mould shall be of specified size ± 0.2 mm. The angle between the adjacent internal faces and between internal faces and top and bottom faces of mould shall be 90-degree ± 0.5 degree. The interior faces of the mould shall be plane surfaces with a permissible variation of 0.03mm.

Concrete test cubes shall be moulded by placing fresh concrete in the mould and compacted as specified in IS 516.

Curing shall be as specified in IS 516. The cubes shall be kept in moist air of at least 90% relative humidity at a temperature of 27-degree C ± 2 -degree C for 24 hours ± 2 hours from the time of adding water to the dry ingredients. Thereafter they shall be removed from the moulds and kept immersed in clean, fresh water and kept at 27-degree C ± 2 -degree C temperature until required for test. Curing water shall be renewed every seven days. A record of maximum and minimum temperatures at the place of storage of the cubes shall be maintained during the period they remain in storage.

The strength shall be determined based on not less than five cube test specimens for each age and each water cement ratio. All these laboratory test results shall be tabulated and furnished to UFRMP. The test results shall be accepted by UFRMP if the average compressive strengths of the specimens tested is not less than the compressive strength specified for the age at which specimens are tested subject to the condition that only one out of the five consecutive tests may give a value less than the specified strength for that age. UFRMP may direct the Firm to repeat the tests if the results are not satisfactory and also make such changes as he considers necessary to meet the requirements specified Proportioning, Consistency, Batching and Mixing of Concrete.

The determination of the water cement ratio and proportion of aggregates to obtain the required strength shall be made from preliminary tests by designing the concrete mix. Controlled concrete shall be used on all concrete work complying with all the requirements of IS: 456. Cube tests shall be carried out by the Firm on the trial mixes before the actual concreting operation starts. Based on the strength of the concrete mix sanction for the use has to be obtained from UFRMP.

If during the execution of the works it is found necessary to revise the mix because of the cube tests showing lower strengths than the required one due to inconsistency of quality of material or otherwise, UFRMP shall ask for fresh trial mixes to be made by the Firm. No claim to alter the rates of concrete work shall be entertained due to such change in mix variations, as it is the Firm's

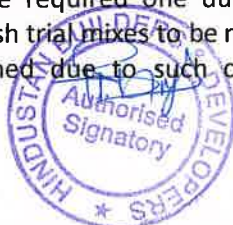

Chief Engineer
 Technical Cooperation Project
 Uttarakhand Forest Resource Management Project
 NTFP Centre, 49, IT Park
 Dehradun-248001

responsibility to produce the concrete of the required grade.

Great care shall be exercised when mixing the actual works concrete using the proportions of the selected trial mix. The final concrete mix shall have the same proportions and same source of cement, fine and coarse aggregates and water as that of the approved selected mix.

A reasonable number of bags should be weighed separately to check the Net weight, where the weight of cement is determined by accepting the manufacturer's weight per bag at the site. Proper control of mixing water is deemed to be of paramount importance. If mixers with automatic addition of water are used, water should be either measured by volume in calibrated buckets, tins or weighed. All measuring equipment shall be maintained in a clean serviceable condition and their accuracy periodically checked and certified and UFRMP's approval obtained.

UFRMP may require the Firm to carry out moisture content tests in both fine and coarse aggregates. The amount of the added water shall then be adjusted to compensate for any observed variations in the moisture contents. BIS: 2386 shall be referred to for determination of moisture content.

No substitution in material, used on the work or alteration in the established proportions shall be made without additional tests to show that the quality and strength of concrete are satisfactory. No alterations shall be permitted without the prior sanction of UFRMP.

4.4.3 Mixing of Concrete

The mixing of concrete shall be strictly carried out in an approved type of mechanical Concrete mixer. The mixing equipment shall be capable of combining the aggregates. Cement and water within the specified time into a thoroughly mixed and uniform mass, and of discharging the mixture without segregation. The entire batch shall be discharged before recharging. Mixing periods shall be measured from the time when all of the solid materials are in the mixing drum, provided that all of the mixing water shall be introduced before one fourth of the mixing time has elapsed. The mixing time in no case shall be less than two minutes. The mixer speed shall not be less than 14 or more than 20 revolutions per minute.

Mixing shall be continued until there is a uniform distribution of the materials and the mass is uniform in color and consistency. Hand mixing of concrete shall not be permitted at all.

For quantities less than 1 cum of concrete, hand mixing may be permitted at the discretion of UFRMP with 10% excess cement quantity.

4.4.4 Grade of Concrete

The different grades of concrete specified shall conform to the strengths as required by IS: 456-1987. Standard deviation shall be calculated as stated in 14.5 of IS: 456-1978. The acceptable criteria for concrete shall be as stated in clause 15 of IS: 456-1978. The assumed standard deviations as given in table 6 of IS: 456-1978 has to be followed and are given here under. However, the minimum cement content shall be as per *Table no. 7: Minimum Cement Content in Concrete* in this bid document.

Grade of Concrete

Grade of Concrete	Assumed Standard Deviation N/sq.mm
M 20	4.6
M 25	5.3

In order to get a quick idea of quality of concrete the optional tests are conducted as stipulated in



K. Sharma
 Chief Engineer
 Technical Cooperation Project
 Uttarakhand Forest Resource Management Project
 NTFP Centre, 49, IT Park
 Dehradun-248001

14.1.1 of IS: 456-1978 and the results are analyzed according to table 5 on page 41 of IS:456-1978.

4.4.5 Controlled Concrete

Controlled concrete shall be used on all concreting works except where specified otherwise the mix proportions for all grades of concrete shall be designed to obtain strengths corresponding to the values specified in table below for respective grades of concrete.

Compressive Strengths at 28 days

Grade	Specified Characteristic Compressive Strength at 28 days (N / mm ²)
M15	18
M20	20
M25	25

The maximum Water: Cement ratio for all controlled concrete works shall be as specified in IS: 456-1978 as Preliminary tests as specified in the BIS code and required by UFRMP shall be carried out sufficiently ahead of the actual commencement of the work with different grades of concrete made from representative samples of aggregates and cement expected to be used on the job to ascertain the ratios by weight of cement of total quantity of fine and coarse aggregates and the water cement ratio required to produce a concrete of specified strength and desired workability.

The minimum cement content for each grade of concrete shall be as per table below.

Minimum Cement Content in Concrete

Grade of Concrete	Minimum Cement Content in Concrete (kg/cum of finished Concrete)
M 20	330
M 25	360
M15	270

At least 4 (four) trial batches are to be made and 7 test cubes should be taken for each batch noting the slump on each mix. These cubes shall then be properly cured and two cubes from each mix shall be tested in a testing laboratory approved by UFRMP at 7 days and others at 28 days for obtaining the ultimate compressive strength. The test reports shall be submitted to UFRMP. The cost of mix design and testing shall be borne by the Firm. On the basis of the preliminary test reports for trial mix, a proportion of mix by weight and water cement ratio will be approved by UFRMP, which will be expected to give the required strength. Consistency and workability and the proportions so decided for different grades of concrete shall be adhered to during all concreting operations. If however at any time UFRMP feels that the quality of material, being used has been changed from those used for preliminary mix design, the Firm shall have to run similar trial mixes to ascertain the mix proportions and consistency. The mix once approved must not be varied without prior approval of UFRMP. However, should the Firm anticipate any change in the quality of future supply of materials than that used for preliminary mix design, he shall inform the same to UFRMP and bring fresh samples sufficiently ahead to carry out fresh trial mixes. UFRMP shall have access to all places and laboratory where design mix is prepared. Design mix will indicate by means of graphs and curves etc. the extent of variation in the grading of aggregates which can be allowed.

In designing the mix proportions of concrete, the quantity of both cement and aggregate shall be determined by weight. All measuring equipment shall be maintained in clean and serviceable condition and their accuracy periodically checked.



[Signature]
 Chief Engineer
 Technical Cooperation Project
 Uttarakhand Forest Resource Management Project
 NTFP Centre, 49, IT Park
 Dehradun-248001

To keep the water cement ratio to the designed value, allowance shall be made for the moisture contents in both fine and coarse aggregates and determination of the same shall be made as frequently as directed by UFRMP. The determination of moisture contents shall be according to IS: 2386 (Part III). Absorption of water by dry aggregates shall not be more than 5%.

4.4.6 Strength Requirements

Where ordinary Portland cement conforming to IS: 269 or Portland blast furnace slag cement conforming to IS: 455 is used the compressive strength requirements for various grades of concrete shall be as shown in table below. Where rapid hardening Portland cement is used the 28 days compressive strength requirements specified in Table- hereunder shall be met in 7 days. The strength requirements specified in table shall apply to both controlled concrete and ordinary concrete.

4.4.7 Strength Requirements of Concrete

Grade of Concrete -Minimum Compressive Strength Concrete in accordance with IS: 516 (In kg/cm)

As per IS: 456-1978 - For 15 cm cube specimens

	at 7 days Work Test	Preliminary	at 28 days Work Test
M 20	135	260	200
M 25	170	320	250

Specified design strength of the concrete for check dams and allied works

Design strength (N/Sq-mm)	Slump (mm)	Maximum water Cement ratio (%)	Maximum aggregate size (mm)	Minimum cement contents (Kg/Cu-m)
18	50	55	40	270

Other requirements of concrete strength as may be desired by UFRMP shall be in accordance with Indian Standard IS: 456 (latest revision). The acceptance of strength of concrete shall be as per clause 5.4 "Sample size and Acceptance Criteria" of IS: 456 (latest revision) subject to stipulation and/or modifications stated elsewhere in this specification if any.

Concrete work found unacceptable shall have to be dismantled and replaced to the satisfaction of UFRMP by the Firm free of cost to UFRMP. No payment will be made for the dismantled concrete, the relevant formwork and reinforcement, embedded mixtures etc. wasted in the dismantled portion shall be made. In the course of dismantling if any damage is done to the embedded items or adjacent structures, the same shall also be made good free of charge by the Firm to the satisfaction of UFRMP. If the water quantity has to be increased in special cases, cement also has to be increased proportionately to keep the ratio of water to cement same as adopted in trial mix design for each grade of concrete.



J. Sharma
 Chief Engineer
 Technical Cooperation Project
 Uttarakhand Forest Resource Management Project
 NTFP Centre, 49, IT Park
 Dehradun-248001

4.4.8 Workability

The workability of concrete shall be checked at frequent intervals by slump test. Where facilities exist and if required by UFRMP, alternatively the compacting factor test in accordance with IS: 1199 shall be carried out. The degree of workability necessary to allow the concrete to be well consolidated and to be worked into the corners of form work and round the reinforcement to give the required surface finish shall depend on the type and nature of the structure and shall be based on experience and tests. The limits of consistency for structures are as specified in the table below:

Limits of Consistency

Placing Conditions	Degree of Workability	Values of Workability
Concreting of shallow Sections with vibration	Very low	20-10 seconds Vee bee time Or 0.75-0.80 Compacting factor
Concreting of lightly reinforced sections with vibration	Low	10-5 seconds or 0.80-0.85 compacting factor
Concreting of lightly reinforced sections without vibration or heavily reinforced section with vibration	Medium	5-2 seconds Vee bee time or 0.85-0.92 compacting factor or 25-75mm slump for 20 mm Aggregate
Concreting of heavily reinforced sections compacting without vibration factor	High	Above 0.92 compacting factor or 75-125 mm slumps for 20 mm aggregate

4.4.9 Workmanship

All workmanship shall be according to the latest relevant standards. Before starting a pour the Firm shall obtain the approval of UFRMP and all other concerned department including safety department, in a "Pour Card" maintained for this purpose. He shall obtain complete instructions about the material and proportion to be used, slump, workability of water per unit of cement, number of test cubes to be taken, finishing to be done and any admixture to be added etc.

4.4.10 Sampling and Testing Concrete in the field

Sampling and Testing of Concrete shall conform to IS: 456 2000.

- a) Facilities required for sampling materials and concrete including whether proof buildings to house the facilities in the field, shall be provided by the Firm at no extra cost. The following equipment with operator shall be made available in serviceable conditions.
- i. Concrete cube-testing machine suitable for 15 cm cubes of 100 ton capacity with proving calibration 1 No.
 - ii. Cast iron cube molds of 15cm size 12 Nos.
 - iii. Slump cone complete with tamping rod 1set
 - iv. Laboratory balance to weigh upto 5 kg with sensitivity of 10gm 1 No.
 - v. BIS sieves for coarse and fine aggregates 1set
 - vi. Set of measures from 5 litre to 0.1 litre 1set
 - vii. Electric oven with thermostat upto 120 Degree C 1 No.



[Signature]
Chief Engineer
 Technical Cooperation Project
 Uttarakhand Forest Resource Management Project
 NTFP Centre, 49, IT Park
 Dehradun-248001

viii. Flakiness gauge	1 No.
ix. Elongation index gauge	1 No.
x. Sedimentation pipette	1 No.
xi. Calibrated glass jar 1.0litrecapacity	2 Nos.
xii. Glass flasks and metal containers	As required
xiii. Chemical reagents like sodium hydroxide, tannic acid, litmus paper etc.-	As required
xiv. Laboratory balance of 2 kg capacity and sensitivity of 1gm-	1 No.
xv. Weighing Machine for cement bags of 6 Nos.:	2 Nos.
xvi. Vernier Calipers	As required
xvii. Thermometer for concrete	1 No.

No concrete of any kind may be placed until the field concrete testing laboratory as specified is provided to the satisfaction of UFRMP. The Firm shall notify UFRMP in advance of all concrete and concrete material testing as provided in the clause to provide UFRMP/his representative with an opportunity to witness all prescribed tests.

At least 6 test cubes of each class of concrete shall be made of every 50cum concrete or part thereof or from different batches as directed by UFRMP. Such samples shall be drawn on each day for each type of concrete. Of each set of 6 cubes, three shall be tested at 7 days age and three at 28 days age. The cubes must be casted from various batches to arrive at an average strength. The laboratory test results shall be tabulated and furnished to UFRMP. UFRMP will pass the concrete if average strength of the specimens tested is not less than the strength specified, subject to the condition that only one out of three consecutive tests may give a value less than the specified strength but this shall not be less than 90% of the specified strength.

Consistency: Slump tests shall be carried out as often as requested by UFRMP and invariably from the same batch of concrete from which the test cubes are made. Slump tests shall be done immediately after sampling.

4.4.11 Concrete Tests

UFRMP may order tests to be carried out on cement, sand, coarse aggregate, water in accordance with the relevant Indian standards.

Tests on Cement shall include:

- Fineness test
- Test for normal consistency
- Test for setting time
- Test for soundness
- Test for tensile strength
- Test for compressive strength
- Test for heat of hydration (by experiment and by calculations) in accordance with BIS 269

Tests on Sand shall include:

- Sieve test
- Test for organic impurities
- Decantation test for determining clay and silt content
- Specific gravity test
- Test for unit weight and bulk age factor



K. Sharma
Chief Engineer
 Technical Cooperation Project
 Uttarakhand Forest Resource Management Project
 NTFP Centre, 49, IT Park
 Dehradun-248001

- f) Test for sieve analysis and fineness modulus

Tests on Coarse Aggregate shall include:

- a) Sieve analysis
- b) Specific gravity and unit weight of dry, loose and rodded aggregate
- c) Soundness and alkali aggregate reactivity
- d) Petrography examination
- e) Deleterious materials and organic impurities
- f) Test for aggregate crushing value

Any or all these tests would normally be ordered to be carried out only if UFRMP feels the materials are not obtained and shall be performed by the Firm at a test laboratory approved by UFRMP. The Firm shall bear the charges of these optional tests. Concrete not made to the requirements of specification in all respects may be rejected by UFRMP in which case it shall be removed and reconstructed entirely at the expense of the Firm.

4.4.12 Load Test or Any Other Tests

In the event of any work being suspected of material or workmanship or both, UFRMP requiring its removal and reconstruction may order, or the Firm may request that it should be load tested in accordance with the following provisions.

The test load shall be 125% of the maximum superimposed load for which the structure was designed. Such test load shall not be applied before 56 days after the effective hardening of concrete. During the test, struts strong enough to take the whole load shall be placed in position leaving a gap under the members. The test load shall be maintained for 24 hours before removal.

If within 24 hours of the removal of the load, the structure does not show a recovery of at least 75% of the maximum deflection shown during the 24 hours under load, the test loading shall be repeated after a lapse of at least 72 hours. The structure shall be considered to have failed to pass the test if the recovery after the second test is not at least 75% of the maximum deflection shown during the second test. If the structure is certified as failed by UFRMP, the cost of all the new construction and the load tests shall be borne by the Firm.

Any other tests, e.g. taking out in an approved manner concrete cores, examination and tests on such cores removed from such parts of the structure as directed by UFRMP, sonic testing etc. shall be carried out by the Firm, if so directed, at no extra cost.

4.4.13 Unsatisfactory tests

Should the results of any test prove unsatisfactory, or the structure shows signs of weakness, undue deflection or faulty construction, the Firm shall remove and rebuild the member or members involved or carry out such other remedial measures as may be required by UFRMP.

4.4.14. Admixtures

General

Admixtures may be used in concrete where required, only with the approval of UFRMP. However, it should be seen that, with the passage of time, neither the compressive strength nor its durability is reduced. Calcium chloride shall not be used for accelerating set of the cement for any concrete containing reinforcement or embedded steel parts. When calcium chloride is permitted to be used, such as in mass concrete works, it shall be dissolved in water and added to the mixing water in an



J.S. Sharma
Chief Engineer
 Technical Cooperation Project
 Uttarakhand Forest Resource Management Project
 NTFP Centre, 49, IT Park
 Dehradun-248001

amount not to exceed 1.5% of the weight of the cement in each batch of concrete. When admixtures are used, the designed concrete mix shall be corrected accordingly. Admixtures shall be used as per manufacturer's instruction and in the manner and with the control specified by UFRMP.

Air Entraining Agents

Neutralized Vinson resin or other approved air in the concrete mix agents shall conform to the requirements of ASTM standard 6.260; Air Entraining Admixtures for Concrete. The recommended total air content of the concrete is 4% + 1%. The method of measuring air content shall be as per IS: 1199.

Water Reducing Admixtures

Water reducing lingo sulfonate admixture may be added in quantities approved by UFRMP. The admixtures shall be added in the form of a solution.

Retarding Admixtures

Retarding agents may be added to the concrete mix in quantities approved by UFRMP.

Water Proofing Agent

Water proofing agents shall conform to IS: 2645.

Other Admixtures

UFRMP may at his discretion allow the Firm to use any other admixture in the concrete.

4.5 Preparation Prior to Concrete Placement, Final Inspection and Approval

4.5.1 General

Before the concrete is actually placed in position, the insides of the formwork shall be inspected to see that they have been cleaned and oiled. Temporary openings shall be provided to facilitate inspection, especially at bottoms of columns and wall forms, to permit removal of sawdust, wood shavings, binding wire, dirt etc. Openings shall be placed or holes drilled so that these materials and water can be removed easily. Such openings/holes shall be suitably plugged later.

The various agencies shall be permitted ample time to install drainage and plumbing lines, floor and trench drains, conduits, hangers, anchors, inserts, sleeves, bolts, frames and other miscellaneous embedment to be cast in the concrete as specified or required or as is necessary for the proper execution of the work as specified in the drawings.

All embedded parts, inserts, etc. supplied by the Firm shall be correctly positioned and securely held in the forms to prevent displacement during depositing and vibrating of concrete.

All anchor bolts shall be positioned and kept in place with the help of properly manufactured templates unless specifically waived in writing by UFRMP.

Slots, openings, holes, pockets etc. shall be provided in the concrete work in the position specified in drawing or required or as directed by UFRMP.

Reinforcement and other items to be cast in concrete shall have clean surfaces that will not impair bond.

Prior to concrete placement, all work shall be inspected and approved by UFRMP and if found unsatisfactory, concrete shall not be poured until after all defects have been corrected.



Chief Engineer
Technical Cooperation Project
Uttarakhand Forest Resource Management Project
NTFP Centre, 49, IT Park
Dehradun-248001

Approval by UFRMP of any and all materials and work as required herein shall not relieve the Firm from his obligation to produce finished concrete in accordance with the requirements of the specifications.

4.5.2 Rain or wash water

No concrete shall be placed in wet weather or on a water-covered surface. Any concrete that has been washed by heavy rains shall be entirely removed, if there is any sign of cement and sand having been washed away from the concrete mixture. To guard against damage, which may be caused by rains, the works shall be covered with tarpaulins immediately after the concrete has been placed and compacted before leaving the work unattended. Any water accumulating on the surface of the newly placed concrete shall be removed by approved means and no further concrete shall be placed thereon until such water is removed. To avoid flow of water over/around freshly placed concrete, suitable drains and sumps shall be provided. During summer season, temperature of water should be maintained, as per the criteria and for the same, icing should be done for concreting work.

4.5.3 Bonding Mortar

Immediately before concrete placement begins, prepared surfaces except formwork, which will come in contact with the concrete to be placed, shall be covered with a bonding mortar (Cement 1: Sand 2, Water cement ratio 65%).

The corrosive matters on the reinforcement should be removed by means of wire brush. Laitance should be removed by means of chiseling from top concrete layer which was earlier concreted.

4.6 Transportation

4.6.1 General

All buckets, containers or conveyors used for transporting concrete shall be mortar-tight, leak proof irrespective of the method of transportation adopted, concrete shall be delivered with the required consistency and plasticity without segregation or loss of slump. However, chutes shall not be used for transport of concrete without the written permission of UFRMP and concrete shall not be re-handled before placing.

4.6.2. Re-tempered or Contaminated Concrete

Concrete must be placed in its final position before it becomes too stiff to work. On no account, water shall be added after the initial mixing. Concrete, which has become stiff or has been contaminated with foreign materials shall be rejected and disposed of as directed by UFRMP.

4.6.3 Avoiding Segregation

Concrete shall, in all cases, be deposited as nearly as practicable directly, in its final position and shall not be re-handled to flow in a manner which will cause segregation, loss of materials, displacement of reinforcement, shuttering or embedded insets, or impair its strength. For locations where, direct placement is not possible, and in narrow forms, the Firm shall provide suitable drop and "Elephant Trunks" to confine the movement of concrete. Special care shall be taken when concrete is dropped from a height, especially if reinforcement is in the way, particularly in column and the walls.



J. Sharma
 Chief Engineer
 Technical Cooperation Project
 Uttarakhand Forest Resource Management Project
 NTFP Centre, 49, IT Park
 Dehradun-248001

4.6.4 Placing by Manual Labor

Except when otherwise approved by UFRMP, concrete shall be placed in the shuttering by shovels or other approved implements, and shall not be dropped from a height more than 1.0 m or handled in a manner, which will cause segregation.

4.6.5. Placing by Mechanical Equipment

The following specification shall apply when placing concrete by use of mechanical equipment is warranted considering the nature of work involved. The control of placing shall begin at the mixer discharge. Concrete shall be discharged by a vertical drop into the middle of the bucket or hopper and this principle of a vertical discharge of concrete shall be adhered to throughout all stages of delivery until the concrete comes to rest in its final position.

Types of Buckets

Central-bottom-dump buckets of a type that provides for positive regulation of the amount and rate of deposition of concrete in all dumping positions, shall be employed.

Operation of Bucket

In placing concrete in large open areas, the bucket shall be spotted directly over the position designated and then lowered for dumping. The open bucket shall clear the concrete already in place and the height of drop shall not exceed 1.0 m. The bucket shall be opened slowly to avoid high vertical bounce. Dumping of buckets on the swing or in any manner, which results in separation of ingredients or disturbance of previously placed concrete, will not be permitted.

4.6.6. Placement of Restricted Forms

Concrete placed in restricted forms by barrows, buggies, cars, short chutes or hand shoveling shall be subject to the requirement for vertical delivery of limited height to avoid segregation and shall be deposited as nearly as practicable in its final position.

4.6.7. Chuting

Where it is necessary to use transfer chutes, specific approval of UFRMP must be obtained to type, length slopes, baffles, vertical terminals and timing of operations. These shall be so arranged that an almost continuous flow of concrete is obtained at the discharge and without segregation. Concrete should flow smoothly in the chute and there should not be any obstruction to the flow. To allow for the loss of mortar against the sides of the chutes, the first mixes shall have less coarse aggregate. During cleaning of chutes, the wastewater shall be kept clear of the forms. Concrete shall not be permitted to fall from the end of the chutes by more than 1.0 m. Chutes, when approved for use shall have slopes not flatter than 1 vertical, 3 horizontal and not steeper than 1 vertical, 2 horizontal chutes shall be of metal or metal lined end of rounded cross section. The slopes of all chute sections shall be approximately the same. The slopes of all chute sections shall be approximately the same. The discharge end of the chutes shall be maintained above the surface of the concrete in the forms.

4.6.8. Placing by Pumping/Pneumatic Placers

Concrete may be conveyed and placed by mechanically operated equipment e.g., pumps or pneumatic placers only with the written permission of UFRMP at no extra cost. The slump shall be held to the minimum necessary for conveying concrete by this method.



[Signature]
Chief Engineer
 Technical Cooperation Project
 Uttarakhand Forest Resource Management Project
 NTFP Centre, 49, IT Park
 Dehradun-248001

When pumping is adopted, before pumping of concrete is started, the pipeline shall be lubricated with one or two batches of mortar composed of one-part cement and two parts sand. Care shall be taken to avoid stoppages in work once pumping has started.

When a pneumatic placer is used, the manufacturer's advice on layout of the pipeline shall be followed to avoid blockages and excessive wear. Restraint shall be provided at the discharge box to cater for the reaction at this end. Manufacturer's recommendations shall be followed regarding concrete quality and all other related matters when pumping/ pneumatic placing equipment is used. It should be noted that no extra payment is made for these items, if required and directed by UFRMP.

4.6.9. Concrete in Layers

Concreting, once started, shall be continuous until the pour is completed. Concrete shall be placed in successive horizontal layers of uniform thickness ranging from 15 cm to 45 cm directed by UFRMP. These shall be placed as rapidly practicable to prevent the formation of cold joints or planes of weakness between each succeeding layer within the pour. The thickness of each layer shall be such that it can be deposited before the previous layer has stiffened. The bucket loads or other units of deposit, shall be spotted progressively along the face of the layer with such overlap as will facilitate spreading the layer to uniform depth and texture with a minimum shoveling. Any tendency to segregation shall be corrected by shoveling stones into mortar rather than mortar on to stones. Such a condition shall be corrected by redesign of mix or other means, as directed by UFRMP.

4.6.10. Cover Blocks

Cover blocks of required size depending on the cover of the reinforcement as mentioned in the drawings shall be prepared in 1:3 cement mortar with fine aggregates and minimum compressive strength of 300 kg/sq.cm.

4.6.11. Bedding of Layers

The top surface of each pour and bedding planes shall be approximately horizontal unless otherwise instructed. Top layer should be rough and with key for further extension of work.

4.7. Compaction

Concrete shall be compacted during placing with approved vibrating equipment until the concrete has been consolidated to the maximum practicable density, as specified in the IS, is free of pockets of coarse aggregate and fits tightly against all form surfaces, reinforcement and embedded fixtures. Particular care shall be taken to ensure that all concrete placed against the form faces and into corners of forms against hardened concrete at joints is free from voids or cavities. The use of vibrators shall be consistent with the concrete mix and caution exercised not to over vibrate the concrete to the point that segregation results.

4.7.1. Type of Vibrators

Vibrators shall conform to BIS specifications. Type of vibrator to be used shall depend on the structures where concrete is to be placed. Shutter vibrators to be effective, shall be firmly secured to the formwork which must be sufficiently rigid to transmit the vibration and strong enough not to be damaged by it. Immersion vibrators in sufficient numbers and each of adequate size shall be used to properly consolidate all concrete. Tapping or external vibrating of forms by hand tools or immersion vibrators will not be permitted.



J. Sharma
Chief Engineer
 Technical Cooperation Project
 Uttarakhand Forest Resource Management Project
 NTFP Centre, 49, IT Park
 Dehradun-248001

4.7.2. Use of Vibrators

The exact manner of application and the most suitable machines for the purpose must be carefully considered and operated by experienced men. Immersion vibrators shall be inserted vertically at points not more than 450 mm apart and withdrawn when air bubbles cease to come to the surface. Immersion vibrators shall be withdrawn very slowly. In no case shall immersion vibrators be used to transport concrete inside the forms. Particular attention be paid to vibration at the top of a lift e.g. in a column or wall.

4.7.3. Melding Successive Batches

When placing concrete in layers, which are advancing horizontally as the work progresses, great care shall be exercised to ensure adequate vibration blending and melding of the concrete between the succeeding layers.

4.7.4. Penetration of Vibrators

The immersion vibrator shall penetrate the layer being placed and also penetrate the layer below while the under layer is still plastic to ensure good bond and homogeneity between the two layers and prevent the formation of cold joints.

4.7.5. Vibrating against Reinforcement/ Formwork

Care shall be taken to prevent contact of immersion vibrators against reinforcement steel. Immersion vibrators shall not be allowed to come in contact with reinforcement steel after start of initial set. They shall also not be allowed to come in contact with forms or finished surfaces.

4.7.6. Use of Form Attached Vibrators

Form attached vibrators shall be used only with specific authorization of UFRMP.

4.7.7. Use of Surface Vibrators

The use of surface vibrators will not be permitted under normal conditions. However, for thin slabs, surface vibrating by specially designed vibrators may be permitted, upon approval of UFRMP.

4.7.8. Stone Pockets and Mortar Pond ages

The formation of stone pockets and mortar pond ages in corners and against faces of forms shall not be permitted. Should these occur, they shall be dug out, reformed and refilled to sufficient depth and shape for thorough bonding, as directed by UFRMP.

4.7.9. Placement Interval

Except when placing with slip forms, each placement of concrete in multiple lift work, shall be allowed to set for at least 24 hours after the final set of concrete and before the start of a subsequent placement.

4.7.10. Special Provision in Placing

When placing concrete in walls with openings, in floors of integral slabs and beam construction and



[Signature]
Chief Engineer
 Technical Cooperation Project
 Uttarakhand Forest Resource Management Project
 NTFP Centre, 49, IT Park
 Dehradun-248001

other similar conditions, the placing shall stop when the concrete reaches the top of the opening in walls or bottom horizontal surface of the slab, as the case may be.

Placing shall be resumed before the concrete in place takes initial set, but not until it has had time to settle as determined by UFRMP.

4.7.11. Placing Concrete Through Reinforcing Steel

When placing concrete through reinforcing steel, care shall be taken to prevent segregation of the coarse aggregate. Where the congestion of steel makes placing difficult, it may be necessary to obtain UFRMP permission for temporarily moving the top steel aside for proper placement & for restoring reinforcement as per drawing.

4.7.12. Bleeding

Bleeding or free water on top of concrete being deposited into the forms, shall be the cause to stop the concrete pour and the conditions causing this defect corrected before any further concreting is resumed.

4.8. Application of Araldite for Bonding of New and Old Concrete

4.8.1. General

Araldite epoxy resins will be used to bond fresh concrete to concrete that is fully cured, to give a monolithic bond capable of transmitting high stresses when traditional bonding agents such as cement slurry cannot always be relied upon to provide good adhesion which is particularly the case when large areas are involved.

The Araldite based formulation shall be applied to a suitably prepared concrete sub-strata and the fresh concrete poured as soon as possible, but always during the 'open time' of the adhesive.

Materials used shall be of best quality like CIBA, FOSROC or ROFF and approved by UFRMP. Manufacturer's instructions shall be followed in all respects. No separate payment shall be paid for this item of work.

4.8.2. Formulation

ARALDITE	GY250100	Parts by weight
Hardener	HY82520	Parts by weight
Hardener	HY83020	Parts by weight
Hardener	HY85020	Parts by weight
Silica Flour	20	Parts by weight

4.8.3. Application

The application of the adhesives shall be as per manufacturer standards.

Preparation of the Substrata

To obtain good adhesion, it is necessary to have clean and sound substrata. Preparation can be carried

Chief Engineer
 Technical Cooperation Project
 Uttarakhand Forest Resource Management Project
 NTFP Centre, 49, IT Park
 Dehradun-248001



out using a variety of techniques including chemical treatment and mechanical methods such as grinding, milling, and abrading, planning and sand blasting. Dust and loose particles resulting from the pretreatment should be removed by vacuum cleaning or oil-free or blast.

Mixing

The resin and hardener should be thoroughly mixed in the dry filler. The mixed, ready to use adhesive should not contain lumps of un-wetted filler and should be of uniform color. For a total weight of 1 kg or less hand mixing should be sufficient. For quantities in excess of 1 kg, the use of a mechanical mixer is recommended.

Pot life and 'Open time'

The pot life is the period during which the ready to use ARALDITE based formulation must be applied. After this period, the mix can no longer be worked and will have begun to set in its container. The table below indicates the pot life at different temperatures:

Mix Temperature	Pot life in minutes
25 Degree C	90 Minutes
30 Degree C	60 Minutes
35 Degree C	45 Minutes

(The figures in this table are for batches less than 1 kilogram).

The 'Open time' is the maximum period of time allowable between application of the ARALDITE adhesive and pouring the fresh concrete. Exceeding the 'Open time' would result in considerably reduced adhesion. The adhesive should be applied to the pre-treated substrata as soon as the components have been mixed and fresh concrete poured immediately afterwards.

Accurate knowledge of the 'Open time' is essential in case the work is interrupted.

Table gives the 'Open time' of ARALDITE based formulations as a function of substrata temperature. In all cases, the adhesives shall be applied immediately after mixing. Any delay between mixing and application will reduce the 'Open time'. Fresh concrete must be poured before the adhesive begins to gel. New to old concrete bonding is not recommended at temperatures below 5-Degree Centigrade, as curing cannot be assured under these circumstances.

Methods of Application

The shape and size of the concrete structure will determine the method of application used. The ARALDITE based adhesive may be applied by hand using brushed, brooms or any other suitable applicator.

Suitability of Fresh Concrete

Best results are obtained when the water/ cement ratio of the new concrete is low as is practicable.

Coverage

One kilogram of the mixed ARALDITE adhesive including hardeners and filler covers an area of 2 to 3 sqm. When applied with a stiff nylon bristle brush. However, the coverage is very much dependent on the finish in the concrete.



J. Sharma
 Chief Engineer
 Technical Cooperation Project
 Uttarakhand Forest Resource Management Project
 NTFP Centre, 49, IT Park
 Dehradun-248001

4.8.4. Handling Precautions

Epoxy resins can cause irritation of the skin in sensitive person if incorrectly handled. Certain safety precautions must therefore be observed and those handling the resins and hardeners should be given suitable instructions. Those working with epoxy resins should, above all, be instructed that personal cleanliness at the place of work is essential. The resin and hardener should not be allowed to come into direct contact with the skin. The most effective protection is achieved by wearing rubber or polythene gloves, the latter having the advantage that they can be replaced when dirty. They are more pleasant to wear if cotton gloves are worn underneath. Parts of the skins, which have come into contact with the resin or hardener, should be washed with lukewarm water and a mild soap. Special cleaning creams may be used as they have proved to be highly suitable.

4.8.5. Construction Joints

A construction joint is defined as a joint in the concrete introduced for convenience in construction at which special measures are taken to achieve subsequent continuity without provision for further relative movement.

No concreting shall be started until UFRMP has approved the method of placing the positions and form of the construction joints and lifts. The construction joints shall be so located as not to impair the strength of the structure. Water stops shall be inserted as per specification requirement.

Concrete placed to form the face of a construction joint shall have all Laitance removed and the aggregate exposed prior to the placing of fresh concrete. The Laitance shall wherever practicable be removed by spraying the concrete where it is still green. The whole of the concrete surface forming part of the joint shall be hacked to expose the aggregate to the 1/3rd size of maximum size of aggregate. Where aggregate is damaged during hacking, it shall be removed from the concrete face by further hacking. All loose matter shall be removed and the exposed surface thoroughly cleaned by wire brushing, air blasting or washing, leaving the surface clean and damp. Immediately before fresh concrete is placed, Cement- sand mortar shall be applied with several mm thickness of proportions (Cement 1 : Sand 2, Water cement ratio 65%) as in the concrete shall be spread in the horizontal face of the construction joint. A drier mix shall be used for the top lift of horizontal face of the construction joint. A drier mix shall be used for the top lift of horizontal pours to avoid Laitance. The new concrete shall be well worked against the prepared face before the mortar sets. Special care shall be taken to obtain thorough compaction and to avoid segregation of the concrete along the joint plane.

When the concrete casting reaches to a certain height, reinforcing bar with 600mm length shall be inserted by 300 mm into the casted concrete as shown below drawing:

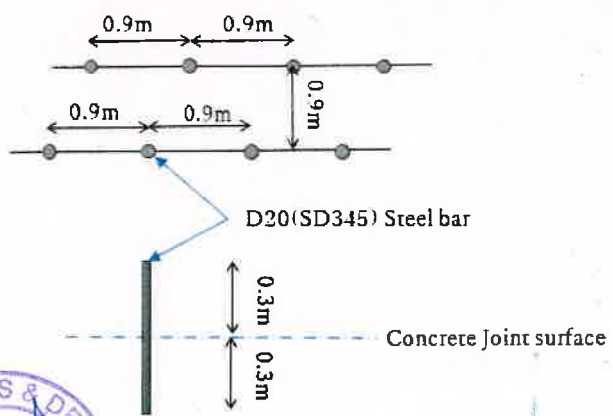

J. Sharma

Chief Engineer
 Technical Cooperation Project
 Uttarakhand Forest Resource Management Project
 NTFP Centre, 49, IT Park
 Dehradun-248001

Required standard of reinforcing bar

Item	Tensile strength (N/sq.mm)	Yield point (N/sq.mm)	Reference
High Strength Deformed steel bar (20mm dia.)	more than 545	500	FE 500 IS 1786

4.8.6. Movement Joints

Movement joints are defined as all joints intended to accommodate relative movement between adjoining parts of a structure, special provision being made where necessary for maintaining the water tightness of the joint. The Firm shall comply with the instructions of manufacturers of proprietary jointing materials and shall, if required by UFRMP, demonstrate that the jointing materials can be applied satisfactorily.

The surface of set concrete in a movement joint shall, as shown on the drawings, be painted with two coats of bituminous paint and new concrete shall be placed against it only when the paint is dry. Expansion joints shall be formed by a separating strip of approved preformed joint filler.

Caulking grooves shall be provided. At all joints where a caulking groove is formed, immediately prior to caulking, the groove shall be wire brushed and loose material removed and blown out by compressed air. After the groove has dried, it shall be primed and caulked with approved sealing compound applied in accordance with the manufacturer's instructions. At all caulked joints, the face of the caulking strip and a width of concrete on either side shall be painted with two coats of paint having the same base as the sealing compound.

4.8.7. Water Stops and Joint Fillers**Water stops**

At all construction, contraction and expansion joints in the water retaining structures and wherever specified or directed by UFRMP, water stops shall be provided. The water stops shall be PVC type or of any other equivalent material as approved by UFRMP. PVC water stops shall have a tensile strength of not less than 13.8 MPa and elongation at break of not less than 285%. Water stops shall not be exposed to direct sunlight for long periods. Before being concreted in water stops shall be cleaned of all foreign materials. Wherever provided, water stops shall be placed in such a manner that they are embedded in the adjacent sections of the panels for equal width.

As far as possible, jointing on site shall be confined to the making of butt joints in straight runs of water stops and all the joints should be monolithic. Where it is agreed with UFRMP that it is necessary to make an intersection or change of direction of any joint, other than a butt joint in a straight run on site, a preliminary joint, intersection or change of direction piece shall be made and submitted to such tests as UFRMP may require. Flexible water stops shall be fully supported in the formwork, free of nails and clear of reinforcement and other fixtures. Damaged water stops shall be replaced and during concreting care shall be taken to place the concrete so that water stops do not bend or distort or displace.

4.8.8. Joining Fillers

Joint fillers shall be of durable, compressible and non-extruding material. Details of jointing material required here. Type of joint, size or width of joint and joint filler material to be used with preferred



[Signature]
 Chief Engineer
 Technical Cooperation Project
 Uttarakhand Forest Resource Management Project
 NTFP Centre, 49, IT Park
 Dehradun-248001

brands if any.

4.8.9. Sealing Compounds

Horizontal joints shall, where used in water-retaining structures be sealed with a cold pouring polysulfide rubber sealing compound of quality equal to, or better than serviced "Para seal". Horizontal joints in roofs, floors and other non-water retaining structures shall be sealed with an approved sealant with properties equal to or better than serviced "Para plastic 41". Vertical joints and joints in the soffits of slabs in both water retaining as well as non-water retaining structures shall be sealed with a trowel or gun applied polysulfide rubber sealing compound such as serviced "Vertiseal" or equivalent. Sealing compounds shall be fully cured before water is permitted to come in contact. At

40C, the curing time would be approximately 7 weeks for polysulfide compounds like CIBA, FOSROC or ROFF as approved by UFRMP.

4.8.10. Tolerances in Concrete Surfaces

Concrete surfaces for the various classes of unformed and formed finishes specified in various clauses shall comply with the tolerances shown in Table hereunder, except where different tolerances are expressly required by the specification.

In the table 'line and level' and 'dimension' shall mean the lines, levels and cross-sectional dimensions as specified and required.

Surface irregularities shall be classified as 'abrupt' or 'gradual'. Abrupt irregularities include by shall not be limited to offsets and fins caused by displaced or misplaced formwork, loose knots and other defects in formwork materials, and shall be tested by direct measurement. Gradual irregularities shall be tested by means of a straight template for plane surfaces and 1.5 m long formed surfaces.

Class of finish	Maximum tolerance (mm)in:			Dimension
	Line & Level	Abrupt Irregularity	Gradual Irregularity	
U 1	12	6	6	-
U 2	6	3	3	-
U 3	6	3	3	-
F 1	12	6	6	+12-6
F 2	6	6	6	+12-6
F 3	3	3	3	+6-

4.9. Curing, Protecting, Repairing and Finishing

4.9.1. Curing

All concrete shall be kept continuously in a damp or wet condition by ponding or by covering with a layer of sacking, canvas, hessian or similar materials and kept constantly wet for at least seven days from the date of placing concrete in case of OPC and 10 days in case of mineral admixture or blended cements are used. The period of curing shall be not less than 10 days for concrete exposed to dry and hot weather condition.



[Signature]

Chief Engineer
 Technical Cooperation Project
 Uttarakhand Forest Resource Management Project
 NTFP Centre, 49, IT Park
 Dehradun-248001

4.9.2. Curing with Water

Fresh concrete shall be kept continuously wet for a minimum period of 10 days from the date of placing of concrete, following a lapse of 12 to 14 hours after laying of concrete. The curing of horizontal surfaces exposed to the drying winds shall however begin as soon as the concrete has hardened. Water shall be applied to formed surfaces immediately upon removal of forms. Quantity of water applied shall be controlled so as to prevent erosion of freshly placed concrete.

4.9.3. Continuous Spraying

Curing shall be assured by use of an ample water supply under pressure in pipes, with all necessary appliances of hose, sprinklers and spraying devices. Continuous fine mist spraying or sprinkling shall be used, unless otherwise specified or approved by UFRMP.

4.9.4. Alternate Curing Methods

Whenever in the judgment of UFRMP, it is necessary to omit the continuous spray method, a covering of clean sand or other approved means such as wet gunny bags, which will prevent loss of moisture from the concrete, may be used. No type of covering will be approved which would stain or damage the concrete during or after the curing period. Covering shall be kept continuously wet during curing period. For curing of concrete in sidewalks, floors, flat roofs of other level surfaces, the ponding method of curing is preferred. The method of containing the ponded water shall be approved by UFRMP. Special attention shall be given to edges and corners of the slabs to ensure proper protection to these areas. The ponded areas shall be kept continuously filled with water during the curing period.

4.9.5. Curing Compound

Surface coating type-curing compounds shall be used only by special permission of UFRMP. Curing compounds shall be liquid type white pigmented, conforming to US Bureau of Reclamation specification. No curing compound shall be used on surfaces where future blending with concrete, water of acid proof membrane or painting is specified. Curing compound shall be used only after getting sufficient/satisfactory test results at site.

4.9.6. Curing Equipment

All equipment and materials required for curing shall be on hand and ready for use before concrete is placed.

4.9.7. Protecting Fresh Concrete

Fresh concrete shall be protected from defacements and damage due to construction operations by leaving forms in place for an ample period as specified in section D3 of this specification. Newly placed concrete shall be protected by approved means such as tarpaulins from rain, sun and winds. Steps as approved by UFRMP shall also be taken to protect immature concrete from damage by debris, excessive lading, vibration, abrasion or contact with other materials, etc. that may impair the strength and/or durability of the concrete. Workmen shall be warned against and prevented from disturbing green concrete during its setting period. If it is necessary that the workmen enter the area of freshly placed concrete, UFRMP may require that bridges be placed over the area.



Chief Engineer
 Technical Cooperation Project
 Uttarakhand Forest Resource Management Project
 NTFP Centre, 49, IT Park
 Dehradun-248001

4.10. Repair and Replacement of Unsatisfactory Concrete

4.10.1. General

Immediately after the shuttering is removed, the surface of concrete shall be very carefully gone over and all defective areas called to the attention of UFRMP who may permit patching of the defective areas or also reject the concrete unit either partially or in its entirety. Rejected concrete shall be removed and replaced by the Firm. Holes shall be filled with mortar composed of one part of cement to one and half parts of sand passing 2.36 mm I.S sieve after removing any loose stones adhering to the concrete. Concrete surfaces shall be finished as described in specifications or as directed by UFRMP. Superficial honey combed surfaces and rough patches shall be similarly made good immediately after removal of shuttering, in the presence of UFRMP and superficial water and air holes shall be filled in. The mortar shall be well worked into the surface with a wooden float. Excess water shall be avoided. Unless instructed otherwise by UFRMP, the surface of the exposed concrete placed against shuttering shall be rubbed down immediately on removal of shuttering to remove fine or other irregularities, care being taken to avoid damaging the surface. Surface irregularities shall be removed by grinding. If reinforcement is exposed or the honeycombing occurs at vulnerable position sends of beams or columns, it may be necessary to cut out the member completely or in part and reconstruct. The decision of UFRMP shall be final in this regard. If only patching is necessary, the edges being cut perpendicular to the affected surface or with a small undercut if possible. Anchors, tees or dovetail slots shall be provided whenever necessary to attach the new concrete securely in place. An area extending several centimeters beyond the edges and the surfaces of the prepared voids shall be saturated with water for 24 hours immediately before the patching material is placed. For small repairs concerned UFRMP shall permit to repair the same and shall be repaired at his directions. For major repairs Firm shall submit the method of statement and on approval of same shall carry such repairs with strict compliance to the method of statement.

4.10.2. Use of Epoxy

The use of epoxy for bonding fresh concrete used for repairs will be permitted upon written approval of UFRMP. Epoxies shall be applied in strict accordance with the instructions of the manufacturer.

4.10.3. Method of Repair

Small size holes having surface dimensions about equal to the depth of the hole, holes left after removal of form bolts, grout insert holes and slots cut for repair of cracks shall be repaired as follows.

The hole to be patched shall be roughened and thoroughly soaked with clean water until absorption stops. A 5 mm thick layer of grout of equal parts of cement and sand shall be well brushed into the surface to be patched, followed immediately by the patching concrete which shall be well consolidated with a wooden float and left slightly protrude of the surrounding surface. The concrete patch shall be built up in 10 mm thick layers, after an hour or more, depending upon weather conditions, it shall be worked off flush with a wooden float and a smooth finish obtained by wiping with hessian. A steel trowel shall be used for this purpose. The mix for patching shall be of the same materials and in the same proportion as that used in the concrete being repaired, although some reduction in the maximum size of the coarse aggregates may be necessary and the mix shall be kept as dry as possible. Mortar filling by air pressure (geniting) shall be used for repair of areas too large and/or too shallow for patching with mortar. Patched surfaces shall be given a final treatment to match the colour and texture of the surrounding concrete. White cement shall be substituted for ordinary cement, if so directed by UFRMP, to match the shade of the patch with the original concrete.



Chief Engineer
 Technical Cooperation Project
 Uttarakhand Forest Resource Management Project
 NTFP Centre, 49, IT Park
 Dehradun-248001

4.10.4. Curing of Patched Work

The patched area shall be covered immediately with an approved non-staining, water-saturated material such as gunny bags which shall be kept continuously wet and protected against sun and wind for a period of 24 hours. Thereafter, the patched area shall be kept wet continuously by a fine spray, or sprinkling for not less than 10 days. All fillings shall be tightly bounded to the concrete and shall be sound, free from shrinkage cracks after the fillings have been cured and dried.

4.10.5. Approval by UFRMP

All materials, procedures and operations used in the repair work shall be subject to the approval of UFRMP.

4.11. Finishing

4.11.1. General

The type of finish for formed concrete surfaces shall be as follows, unless varied by the design/architectural drawings and specifications. When the structure is in service all the surfaces shall receive no special finish, except repair of damaged or defective concrete, removal of fine and abrupt irregularities, filling defective concrete, filling of holes left by form ties and rods and clean-up of loose or adhering debris. Surfaces which will be exposed to the weather and which would normally be level, shall be sloped for drainage. Unless a horizontal surface or the slope required is specified, the tops of narrow surfaces such as stair treads, walls, curbs and parapets shall be sloped across the width approximately 1 in 30. Broader surfaces such as walkways, and platforms shall be sloped about 1 in 50. Surfaces that will be covered by backfill or concrete, subfloors to be covered with concrete topping, terrazzo or quarry tiles and similar surfaces shall be smooth ascended and leveled to produce even surfaces. Surface irregularities shall not exceed 6 mm. Surfaces which will not be covered by backfill, concrete or tile toppings such as outside decks, floors of galleries and sumps, parapets, gutters, sidewalks, floors and slabs, shall be consolidated, screened and floated. Excess water and laitance shall be removed before final finishing. Floating maybe done with hand or power tools and started as soon as the screened surface has attained a stiffness to permit finishing operations and these shall be the minimum required to produce a surface uniform in texture and free from screened marks or other imperfections. Joints and edges shall be tooled as specified or as directed by UFRMP.

4.11.2. Standard Finish for Exposed Concrete

Exposed concrete shall mean any concrete, exposed to view upon completion of the works. Unless otherwise specified, the standard finish for exposed concrete shall be a smooth finish. A smooth finish shall be obtained with the use of lined or plywood forms having smooth and even surfaces and edges. Panels of forms shall be of uniform size and be as large as practicable and installed with closed joints. Upon removal of forms the joint marks shall be smoothed off and all blemishes, protections etc., removed leaving the surfaces smooth.

4.11.3. Integral Cement Concrete Finish

When specified, an integral cement concrete finish of specified thickness for floors and slabs shall be applied either monolithic or bonded, as specified or directed by UFRMP. The surface shall be tested with a straight edge and any high and low spots eliminated. Floating or troweling of the finish shall be permitted only after all surface water has evaporated. Dry cement or a mixture of dry cement and sand shall not be sprinkled directly on the surface of the cement finish to absorb moisture or to stiffen the mix.



[Signature]
Chief Engineer
 Technical Cooperation Project
 Uttarakhand Forest Resource Management Project
 NTFP Centre, 49, IT Park
 Dehradun-248001

4.11.4. Cement Plaster

All joints in masonry shall be raked to a depth of 12 mm with hooked tool made for the purpose when the mortar is still green and in any case within 48 hours of its laying. The surface to be rendered shall be washed with fresh clean water free from all dirt, loose material, grease etc. and thoroughly wetter for 6 hours before plastering work is commenced. Concrete surfaces to be rendered will however be kept dry. The wall should not be too wet but only damp at the time of plastering. The damping shall be uniform to get uniform bond between the plaster and the wall.

Cement shall be mixed thoroughly in dry condition and then just enough water added to obtain a workable consistency. The quality of water, sand and cement shall be as per relevant IS. The mortar thus mixed shall be used immediately and in no case shall the mortar be allowed to remain for more than 25 minutes after mixing with water.

Curing of plaster shall be started as soon as the applied plaster has hardened enough so as not to be damaged. Curing shall be done by continuously applying water in a fine spray and shall be carried out for at least 7 days.

Plastering shall be done on both faces of brick masonry in cement mortar (1:2) and 20 mm thick unless otherwise specified.

Plastering work shall be carried out in two layers, the first layer being 14 mm thick and the second layer being 6 mm thick. The first layer shall be dashed against the prepared surface with a trowel to obtain an even surface. The second layer shall then be applied and finished leaving an even and uniform surface, trowel finished unless otherwise approved by UFRMP.

4.11.5. Rubbed Finish

A rubbed finish shall be provided only on exposed concrete surfaces. Upon removal of forms, all fins and other projections on the surfaces shall be carefully removed, offsets leveled and voids and/or damaged sections immediately saturated with water and repaired by filling with a concrete or mortar of the same composition as was used in the surface. The surfaces shall then be thoroughly wetted and rubbed with carborundum or other abrasive. Cement mortar may be used in the rubbing, but the finished surfaces shall not be brush coated with either cement or grout after rubbing. The finished surfaces shall present a uniform and smooth appearance.

4.11.6. Protection

All concrete shall be protected against damage until final acceptance by UFRMP.

4.11.7. Hot Weather Requirement

All Concrete work performed in hot weather shall be in accordance with IS:456, except as herein modified. Admixtures may be used only when approved by UFRMP. Adequate provisions shall be made to lower give limit concrete temperatures by cool ingredients, eliminating excessive mixing, preventing exposure of mixers and conveyors to direct sunlight and the use of reflective paint on mixers, etc. The temperature of the freshly placed concrete shall not be permitted to exceed 38 degrees centigrade.

Consideration shall be given to shading aggregate stockpiles from direct rays of the sun and spraying stockpiles with water, use of cold water when available, and burying, insulating, shading and/or painting white the pipelines and water storage tanks and conveyance.



Chief Engineer
 Technical Cooperation Project
 Uttarakhand Forest Resource Management Project
 NTFP Centre, 49, IT Park
 Dehradun-248001

In order to reduce loss of mixing water, the aggregate, wooden forms, subgrade, adjacent concrete and other moisture absorbing surfaces shall be well wetted prior to concreting, placement and finishing shall be done as quickly as possible. Extra precautions shall be taken for the protection and curing of concrete. Consideration shall be given to continuous water curing and protection against high temperatures and drying hot winds for a period of at least 7 days immediately after concrete has set and after which normal curing procedures may be resumed.

Placing Concrete Underwater

- a) Under all ordinary conditions, all foundations shall be completely dewatered and concrete placed in the dry. However, when concrete placement under water is necessary, all work shall conform to IS:456 and the procedure shall be as follows:
 - (i) Method of Placement
Concrete shall be deposited underwater by means of drop bottom buckets of approved type.
 - (ii) Direction, Inspection and Approval
All work requiring placement of concrete underwater shall be designed, directed and inspected with due regard to local circumstances and purposes. All underwater concrete shall be placed according to specifications approved by UFRMP.
- b) Special precautions shall be taken for prevention of lifting of concrete due to uplift pressure of subsoil water.

4.12. Precast Concrete

4.12.1. General

Precast concrete units, whether manufactured on or off site, shall comply in every way with the provisions of the contract for in situ concrete. Wherever possible, precast units shall be hydraulically pressed. When ready for incorporation in the works, precast units shall be responsible for the accuracy of the level, shape of the bed or platform. A suitable serial number and the date of casting shall be impressed or painted on each unit.

4.12.2. Striking Forms

Side shutters shall not be struck in less than 24 hours after depositing concrete and no precast unit shall be lifted until the concrete reaches' strength of at least twice the stress to which the concrete may be subjected to at the time of lifting.

4.12.3. Precast Units

The lifting and removal of precast units shall be undertaken without causing shock, vibration or undue bending stresses to or in the units. Before lifting and removal takes place, Firm shall satisfy UFRMP or his representative that the methods he proposes to adopt for these operations will not over-stress or otherwise effect seriously the strength of the precast units. The reinforced side of the units shall be distinctly marked.

4.12.4. Curing

All precast work shall be protected from the direct rays of the sun for at least 7 days after casting and during that period each unit shall be kept constantly watered or preferably be completely immersed in water if the size of the unit so permits.



 Chief Engineer
 Technical Cooperation Project
 Uttarakhand Forest Resource Management Project
 NTFP Centre, 49, IT Park
 Dehradun-248001

4.12.5. Slots, Openings etc.

Sand shall be such as to produce a flow able grout without any tendency to segregate. Sand for general grouting purposes shall be graded within the following limits:

Passing BIS 2.36 mm sieve 95 to 100%

Passing BIS 1.18 mm sieve 65 to 95%

Passing BIS 300-micron sieve 10 to 30%

Passing BIS 150-micron sieve 3 to 10%

Sand for fluid grouts shall have the fine material passing the 300- and 150-micron sieves at the upper limits specified above. Sand, for still grouts, shall meet the usual grading specifications for concrete laitance. Anchor bolts, anchor bolt holes and the bottoms of equipment and column base plates shall be cleaned of all oil, grease, dirt and loose material. The use of hot, strong caustic solution for this purpose will be permitted. Prior to grouting, the hardened concrete surfaces to be grouted shall be saturated with water. Water in anchor bolt holes shall be removed before grouting is started. Forms around base plates shall be reasonably tight to prevent leakage of the grout. Adequate clearance shall be provided between forms and base plate to permit grout to be worked properly into place. Grouting, once started, shall be done quickly and continuously to prevent segregation, bleeding and breakdown of initial set. Grout shall be worked from one side of one end to the other to prevent entrapment of air. To distribute the grout and to ensure more complete contact between base plate and foundation and to help release trapped air, link chains can be used to work the grout into place. Grout throughout holes in base plates shall be by pressure grouting. Variations in grout mixes and procedures shall be permitted if approved by UFRMP.

Mixing, batching, cleaning, preparation of surface and curing of non-shrinking grout shall be done as per manufacturer's instructions. Brands like FOSROC or BUILDMASTER etc. shall be used as per manufacturer specifications.

4.12.6. Inspection

All materials, workmanship and finished construction shall be subject to continuous inspection and approval of UFRMP.

All materials supplied by the Firm and all work or construction performed by the Firm which is rejected as not being in conformity with the specifications and requirements, shall be immediately replaced.

All concrete shall be protected against damage until final acceptance by UFRMP.

4.12.7. Clean-Up

Upon completion of the concrete work, all forms, equipment, construction tools, protective coverings and any debris resulting from the work shall be removed from the premises.

All debris i.e. empty containers, scrap wood, etc., shall be removed to "dump" daily, or as directed by UFRMP. The finished concrete surfaces shall be left in a clean condition satisfactory to UFRMP.

4.12.8. Records of Concreting

An accurate and up to date record showing times, dates, weather and temperature conditions when various positions of all the concrete structures forming the works were concreted will be kept by the Firm and shall be countersigned by UFRMP. If the Firm fails to sign UFRMP's record, it shall



Chief Engineer
 Technical Cooperation Project
 Uttarakhand Forest Resource Management Project
 NTFP Centre, 49, IT Park
 Dehradun-248001

nevertheless be regarded as correct and binding on the Firm.

The Firm has to submit concrete pour card in duplicate duly to be signed to UFRMP for each type of concreting work. Firm shall keep copy of it, after UFRMP has checked and signed the pour card.

4.12.9. Foundation Bedding, Bonding and Jointing

In no case foundation shall rest on any loose strata or loose pockets etc. even though it has reached level shown on design drawings and referred back to UFRMP. All surfaces upon or against which concrete will be placed shall be suitably prepared by thoroughly cleaning, washing and dewatering, as specified or as UFRMP may direct, to meet the various situations encountered in the work. Soft or spongy areas shall be cleaned out and backfilled with lean concrete or clean sand fill compacted. Prior to construction of formwork for any item where soil will act as bottom form, approval shall be obtained from UFRMP for the suitability of the soil.

4.12.10. Preparation of Rock Strata of Foundations

To provide tight bond with rock foundations, the rock surface shall be prepared and the following general requirements shall be observed.

Concrete shall not be deposited on large sloping rock surfaces. Where required by UFRMP, the rock shall be cut to form rough steps or benches to provide roughness or a more suitable bearing surface.

Rock foundation stratum shall be prepared by picking, barring, wedging and similar methods which will leave the rock in an entirely sound and unshattered condition.

Shortly before concrete is placed, the rock surface shall be cleaned with high-pressure water and air jet even though it may have been previously cleaned in that manner.

Prior to placing concrete, the rock surface shall be kept wet for a period of 2 to 4 hours unless otherwise directed by UFRMP.

Before placing concrete on rock surfaces all water shall be removed from depressions to permit thorough inspection and proper bonding of the concrete to the rock.

4.13. Formwork

4.13.1. Formwork, Fixing and General

All formwork shall be constructed of waterproof plywood or preferably sheet metal. Plywood used for formwork shall be conforming to BIS: 4990 i.e. Specification for plywood for concrete shuttering works. The materials for formwork shall got approved by UFRMP before starting the work. Formwork shall be firmly supported, adequately strutted, braced and tied to withstand the placing and vibrating of concrete and the effects of weather.

The Firm shall be responsible for the calculations and designs for the formwork, and if required, shall submit them to UFRMP for approval before construction. On formwork to external faces, which will be permanently, exposed, all horizontal and vertical formwork joints shall be so arranged that joint lines will form a uniform pattern on the face of the concrete. Where the Firm proposes to make up the formwork for standard sized manufactured form work panels, the size of such panels shall be approved by UFRMP before they are used in the construction of the Works. The finished appearance of the entire elevation of the structure and adjoining structures shall be considered when planning the pattern of joint lines caused by formwork and by construction joint to ensure continuity of



[Signature]
Chief Engineer
 Technical Cooperation Project
 Uttarakhand Forest Resource Management Project
 NTFP Centre, 49, IT Park
 Dehradun-248004

horizontal and vertical lines.

Faces of form work in contact with concrete shall be free from adhering foreign matter, projecting nails and the like, splits or other defects, and all form work shall be clean and free from standing water, dirt, shavings, chippings or other foreign matter. Joints shall be sufficiently watertight to prevent the escape of mortar or the formation of fins or other blemishes on the face of the concrete and no bleeding should be allowed through the joints.

Form work shall be provided for the top surfaces of sloping work where the slope exceeds fifteen degrees from the horizontal (except where such top surface is specified as spaded finish) and shall be anchored to enable the concrete to be properly compacted and to prevent flotation, care being taken to prevent air being trapped.

Openings for inspection of the inside of the form work and for the removal of water used for washing down shall be provided and so formed as to be easily closed before placing concrete. Before placing concrete, all bolts, pipes or conduits or other fixtures which are to be built in shall be fixed in their correct positions, and cores and other devices for forming holes shall be held fast by fixing to the formwork or otherwise. Holes shall not be cut in any concrete without approval of UFRMP.

All exterior angles on the finished concrete of 90 degree or less shall be given 20 mm x 20 mm chamfers unless otherwise ordered by UFRMP.

No ties or bolts or other device shall be built into the concrete for the purpose of supporting formwork without the prior approval of UFRMP. The whole or part of any such supports shall be capable of removal so that no part remaining embedded in the concrete shall be nearer than 50 mm from the surface in the case of reinforced concrete and 150 mm in the case of un-reinforced concrete. Holes left after removal of such supports shall be neatly filled with well-rammed dry-pack mortar.

Formwork in contact with the concrete shall be treated with suitable non-staining mould oil to prevent adherence of the concrete except where the surface is subsequently to be rendered. Care shall be taken to prevent the oil from coming in contact with reinforcement or with concrete at construction joints. Surface retarding agents shall be used only where ordered by UFRMP.

No formwork shall be started or placed unless the requirement work is fully completed and checked by UFRMP.

Necessary cover blocks shall be provided before starting connection.

4.13.2. Removal of Formwork

Formwork shall be so designed as to permit any removal without resorting to hammering or levering against the surface of the concrete. The periods of time elapsing between the placing of the concrete and the striking of the loads likely to be imposed on the concrete and shall in any case be not less than the periods shown in Table below 4.13.2 (i). Where soffit formwork is constructed in a manner during and after such removal of a sufficient number of adequate supporting props in an undisturbed condition, Firm may, with the agreement of UFRMP, remove the formwork at the earlier times listed below provided that the props are left in position.

Notwithstanding the foregoing, Firm shall be held responsible for any damage arising from removal of formwork before the structure is capable of carrying its own weight and any incidental loading.

Striking shall be done slowly with utmost care to avoid damage to projections and without shock or vibration, by gently easing the wedges. If after removing the formwork it is found that timber has been embedded in the concrete. It shall be removed and made good as specified earlier.



[Signature]
Chief Engineer
 Technical Cooperation Project
 Uttarakhand Forest Resource Management Project
 NTFP Centre, 49, IT Park
 Dehradun-248001

Reinforced temporary openings shall be provided, as directed by UFRMP, to facilitate removal of formwork which otherwise may be inaccessible.

For liquid retaining structures, no sleeves for through bolts shall be used nor shall through bolts be removed as indicated above. The bolts, in this case, shall be cut at 25 mm depth or more from the surface and then the hole shall be made good by cement sand mortar of the same proportions as the concrete just after striking the formwork.

Table 4.13.2 (i) Removal of Form work (Stripping Time):

In normal circumstance and where various types of cements are used, forms, may generally be removed after the expiry of the following periods:

Type of Form work	Minimum period Before Striking Form work for OPC 33 grade	Minimum period Before Striking Form work for OPC 43 grade	Minimum period Before Striking Form work for PPC
(a) Vertical form work to columns, walls, beams	16-24 h	16-24 h	24-36 h
(b) Soffit form work to slabs (Props to be re-fixed immediately after removal of formwork)	3 days	3 days	4 days
(c) Soffit form work to beams (Props to be re-fixed immediately after removal of formwork)	7 days	7 days	10 days
(d) Props to slabs: (1) Spanning upto 4.5m (2) Spanning over 4.5m	7 days 14 days	7 days 14 days	10 days 20 days
(e) Props to beams and arches: (1) Spanning upto 6m (2) Spanning over 6m	14 days 21 days	14 days 21 days	20 days 30 days

4.13.3. Formed Surfaces - Classes of Finish

Finishes to formed surfaces of concrete shall be classified as F1, F2, or F3, or such other special finish as may be particularly specified. Where the class of finish is not specified the concrete shall be finished to Class F1.

Formwork for Class F3 finish shall be lined with as large panels as possible of non-staining material with a smooth unblemished surface such as sanded plywood or hard compressed fiber board, arranged in a uniform approved pattern and fixed to back form work by oval nails. Unfaced wrought boarding or standard steel panels shall not be permitted.

Formwork for Class F2 finish shall be faced with wrought tongued and grooved boards or plywood or



[Signature]
Chief Engineer
 Technical Cooperation Project
 Uttarakhand Forest Resource Management Project
 NTFP Centre, 49, IT Park
 Dehradun-248001

metal panels arranged in a uniform approved pattern free from defects likely to detract from the appearance of the surface.

4.13.4. Defects in Formed Surfaces

Workmanship in formwork and concreting shall be such that concrete shall normally require no making good, surfaces being perfectly compacted and smooth.

If any blemishes are revealed after removal of formwork, UFRMP's decisions concerning remedial measures shall be obtained immediately. These measures may include, but shall not be limited to the following:

Fins, pinhole bubbles, surface discoloration and minor defects may be rubbed down with sacking immediately after the formwork is removed.

Abrupt and gradual irregularities may be rubbed down with carborundum and water after the concrete has been fully cured. These and any other defects shall be remedied by methods approved by UFRMP which may include using a suitable epoxy resin or, where necessary, cutting out to a regular dovetails shape at least 75 mm deep and refilling with concrete over steel mesh reinforcement sprung into the dovetail.

The form work shall be checked by UFRMP before the form work starts and form found defective shall be rejected and the same can be used after rectifying the defects and with due approval of UFRMP.

4.13.5. Holes to be Filled

Holes formed in concrete surfaces by form work supports or the like shall be filled with dry- pack mortar made from one part by weight of ordinary Portland cement and one part fine aggregate passing BIS sieve 1.18 mm. The mortar shall be mixed with only sufficient water to make the materials stick together when being molded in the hands.

The Firm shall thoroughly clean any hole that is to be filled with dry-pack mortar and where the surface has been damaged, the Firm shall break out any loose, broken or cracked concrete or aggregate. The concrete surrounding the hole shall then be thoroughly soaked after which the surface shall be dried so as to leave a small amount of free water on the surface. The surface shall then be dusted lightly with ordinary Portland cement by means of a small dry brush until the whole surface that will come into contact with the dry- pack mortar has been covered and darkened by absorption of the free water on the surface. Any dry cement in the hole shall be removed.

The dry-pack material shall then be placed and packed in layers having a compacted thickness not greater than 15 mm. The compaction shall be carried out by use of a hardwood stick and a hammer and shall extend over the full area of the layer, particular care being taken to compact the dry-pack against the sides of the hole. After compaction, the surface of each layer shall be scratched the dry-pack fill and striking the block several times. Steel finishing tools shall not be used and water shall not be added to facilitate finishing.

4.13.6. Bracing, Struts and Props

Form work shall be braced, strutted, propped and so supported that it shall not deform under weight and pressure of the concrete and also due to the movement of men and other materials. Bamboo shall not be used as props or cross bearers. The Firm shall submit the detailed design and methodology with applicable drawings if any of Formwork system for different works for approval of UFRMP.



[Signature]
 Chief Engineer
 Technical Cooperation Project
 Uttarakhand Forest Resource Management Project
 NTFP Centre, 49, IT Park
 Dehradun-248001

5. BRICK AND STONE MASONRY

5.1 Cement Mortar

Mortar for brick masonry shall be prepared as per IS:2250, Manholes / Inspection chambers shall be constructed in brick masonry with cement mortar (1:2) unless otherwise specified. Gauge boxes for sand shall be of such dimensions that one bag containing 50 kg of cement forms one unit. The sand shall be free from clay, shale, loam, alkali and organic matter and shall be of sound, hard, clean and durable particles. Sand shall be as approved by UFRMP. If required by UFRMP and shall be thoroughly washed till it is free of any contamination.

For preparing cement mortar, the ingredients shall first be mixed thoroughly in dry condition. Water shall then be added and mixing continued to give a uniform mix of required consistency. Cement mortar shall be used within 25 minutes of mixing. Mortar left unused in the specified period shall be rejected.

The Firm shall arrange for tests on mortar samples if so required by UFRMP. Re-tempering of mortar shall not be permitted

5.2. Mortar

The proportion of the cement mortar used for the masonry work shall be as specified on the various drawings for different places/types of construction, bills of quantities, specifications for each part of the work.

Mortar should be prepared by volume using boxes of appropriate sizes on clean platform or this sheet to avoid mixing of foreign material and maintain consistency of mortar.

Sharp coarse sand is mixed with the required quantity of cement for the preparation of the mortar. Mortar shall be prepared in accordance with IS:2250-1981. The sand used for the masonry mortar shall meet the requirements as specified in IS:2116-1980. Sand for masonry mortars. Sand and cement of required proportions are mixed in small quantities in a dry state first and then water is added to make the mortar of required the consistency suitable for the type of work it is required as directed by UFRMP. No left-over mortar shall be used and therefore only that much quantity of mortar that can be consumed within 30 minutes shall be mixed in batches.

5.3. Curing

Fresh work shall be protected from rain by covering the work suitably. Masonry work as it progresses shall be thoroughly kept wet by watering on all the faces for at least 7 (Seven) days after completion of the parts of the work. Proper watering cans, flexible pipes, nozzles shall be used for the purpose. The top of the masonry work shall be kept flooded at the close of the day's work by constructing fillets of mortar 40 mm high all around the edges of the top course. In case of fat lime mortar curing shall start two days after construction of masonry and shall continue for seven days. No additional payment is admissible for curing and the rates quoted are deemed to be inclusive of the cost of curing.

5.4. Stone Masonry for Retaining Walls and other works

Stone masonry in general is to be used for retaining walls as per UFRMP's instructions and as per drawings, which will be supplied during course of construction to suit site conditions.

All Indian Standards relevant to stone masonry work shall be applicable:



J. Sharma
 Chief Engineer
 Technical Cooperation Project
 Uttarakhand Forest Resource Management Project
 NTFP Centre, 49, IT Park
 Dehradun-248001

5.5. Uncoursed Stone Masonry

Uncoursed stone masonry shall be built in layers not exceeding 450 mm in height. No stone shall be less in breadth than 14 times its height and less in length than twice its height. Every stone whether large or small, shall be laid in its natural bed and set flush in mortar, and the small stones used for wedging or filling being carefully selected to fit the interstices between the large stones. Care shall be taken to see that no dry work or hollow space is left in the masonry. The stones shall be so arranged as to break joints at least every 80 mm and long vertical joints shall be avoided. The joints at the face shall be finished off neatly, being struck and smoothed with a trowel while the mortar is fresh. The upper surface of the work shall be brought to a uniform level at the height of each course. The faces of masonry walls shall be kept in perfect plumb and where batter has to be given it shall, be uniform. The stones at all comers and junctions of walls shall be of large sizes and hammer dressed to the correct angle.

Each stone shall be thoroughly wetted before being used in the work. The masonry shall be kept thoroughly wet during the progress of the work, (care being taken to water it even on Sundays and Holidays, special labour being employed if so required for this purpose) until it becomes hard. As far as practicable, the whole of the masonry shall be raised in one uniform level and no part of the masonry shall be allowed to rise more than 1 m above the rest to avoid unequal settlement. If raising one part of wall before the other becomes unavoidable the end of the raised portion shall be racked back in steps to prevent cracks developing at the junction of the old and new work. Care shall be taken to see that the sides of the wall are not built separately from the hearting the faces and internal filling being done simultaneously. The stones shall overlap and cross each other as much as possible. No course shall be laid unless the previous course is perfectly set.

At least one header or through stone per m² of wall face shall be built into the work. The headers or through stones shall be at least 0.05 m in area on all face and shall have at least 0.025-meter area at the back face. Where the thickness of the wall is more than 600 mm a series of through stones shall be laid through the work so as to form a tie from front to back, breaking joints or overlapping each other for at least 150 mm. No stone whose length is less than 600 mm shall be used in such work as a header.

All through stones shall be marked inside and outside and the marks shall be retained until ordered by UFRMP to be removed. Sufficient number of headers shall be collected on site before commencing any masonry work. Where adequately sized through stones are not available in required quantities, the use of pre-cast plain concrete headers in M-20 mix may be permitted at the discretion of UFRMP. No extra payment will be made for the provision of substitute headers in concrete

Quoins shall be 150 mm high and formed of header stones at least 300 mm long. They shall be laid lengthwise alternately along each face and square on their beds, which shall be dressed to a depth of at least 80 mm.

Weep holes 80 mm wide and 150 mm in height shall be provided in retaining walls at the rate of one per square meter as specified or directed. They shall be pointed with 1:2 cement sand mortar after raking the joints to a minimum depth of 25 mm.

Completed masonry shall be kept wet for a minimum period of 14 days. In wet weather newly laid masonry shall be protected from the effects of heavy rainfall by tarpaulins or other approved material.

5.6. Pointing of uncoursed Masonry

Joints in exposed masonry faces shall be formed while the mortar is still green and shall be finished as flush joints, weathered joints, round-recessed joints or square-recessed joints as directed by UFRMP.



Chief Engineer
 Technical Cooperation Project
 Uttarakhand Forest Resource Management Project
 NTFP Centre, 49, IT Park
 Dehradun 248001

5.7. Stone Pitching

Stone pitching: to slopes shall be carried out where specified or as directed by UFRMP. Stone for pitching shall be obtained from an approved source and shall be hard, sound, durable, clean and generally as specified. The minimum dimension of any stone shall be, at least equal to the specified thickness of the pitching.

After excavation and trimming, slopes to be pitched shall be spread with a 75mm thick layer of crusher run rock or graded coarse aggregate ranging from 75mm particle size to fines. The slope shall then be hand packed with hard broken rock to a total thickness of 150 mm, each stone being individually placed and rammed home, with smaller stones edged into the cracks. 50mm dia. weep-holes shall be provided where specified at intervals not exceeding two meter's in both directions. Joints in stone pitching shall be flushed up with sand/cement mortar on completion.

5.8. Rubble Packing

Rubble used for packing under structures, foundations, etc. shall be hard and durable rock, free from veins, flaws and other defects. The quality and size of the rubble shall be subject to the approval of UFRMP.

Rubble shall be hand packed as directed by UFRMP. They shall be laid closely in position on the sub-grade. All interstices between the stones shall be wedged in with smaller stones of suitable size well driven to ensure tight packing and complete filling of interstices. Such filling shall be carried out simultaneously with the placing in position of rubble stones and shall not lag behind.

Small interstices shall be filled with hard clean sand and well-watered and rammed.

6. EXPANSION JOINTS

6.1. Expansion Joints

6.1.1. General

The item of providing expansion joints in concrete includes all the material, labour, tools and plants necessary for completing the item in best workmanlike manner.

6.1.2. Material

The Material to be used in the joints shall be ribbed PVC water stop of specified width approved by UFRMP, bitumen impregnated fiber board as filler conforming to IS: 10566 and approved sealant material (In case of movement joint only). In addition, IS 12200 and 1838 shall also be adhered to.

6.1.3. Application

Expansion joints shall be provided where necessary. The joints shall be so located that in no case the slab shall be more than 45 meters long in one stretch. The joint shall be continuous in length and shall be properly joined together or welded at all junction along its length.

This may be achieved by placing a strip of filler material in position adjacent to the face of concreted slab panel while concreting the adjoining panel. The space above, water stop shall be filled with sealant material overlaid by filler material like thermocol and poly-sulphide sealant as shown in the drawing.



[Signature]
Chief Engineer
 Technical Cooperation Project
 Uttarakhand Forest Resource Management Project
 NTFP Centre, 49, IT Park
 Dehradun-248001

7. Hydroseeding & Vegetation Regeneration

7.1. Definition and Purpose

Hydroseeding typically consists of applying a mixture of mulch (which includes wood fiber, rice, straw, compost and wood combination or other natural fibers), seed, fertilizer, soil amendments and stabilizing emulsion with hydro-mulch equipment. The mulch and stabilizing emulsion temporarily protect exposed soils from erosion by water and wind while the seed germinates and establishes permanent cover.

7.2. Appropriate Applications

Hydroseeding is applied on the cut slopes or other locations shown in the Drawings or as directed by the UFRMP.

7.3. Design Parameters

In order to select appropriate hydroseeding mixtures, an evaluation of site conditions shall be performed with respect to:

- a) Soil types and conditions
- b) Maintenance requirements
- c) Site topography
- d) Sensitive adjacent areas
- e) Season and climate
- f) Water availability
- g) Vegetation types
- h) Plans for permanent vegetation

Selection of hydroseeding mixtures shall be approved on a project by project basis by a landscape architect or revegetation specialist.

7.4. Application

The following steps shall be followed for implementation of hydroseeding:

- a) Hydro-seeding is accomplished using a multi-step process. The multi-step process ensures maximum direct contact of the seeds to soil. When applying the mixture of fiber, seed etc., the seed rate shall be increased to compensate for damage to seed from the hydroseeding equipment or seeds having inadequate direct contact with the soil.
- b) Prior to application, the slope, fill area or area to be seeded shall be roughened with the furrows trending along the contours.
- c) A mulch shall be applied to keep seeds in place and to moderate soil moisture and temperature until the seeds germinate and grow.
- d) Each seed bag shall be delivered to the site sealed and clearly marked with species, purity, percent germination, dealer's guarantee and dates of test. This documentation shall be provided to UFRMP. The container shall be labeled to clearly reflect the amount of Pure Live Seed (PLS) contained. All legume seed shall be pellet inoculated. Inoculant sources shall be species-specific and shall be applied at a typical rate of 2 kg of inoculant per 100 kg of seed (2 percent inoculant by weight).

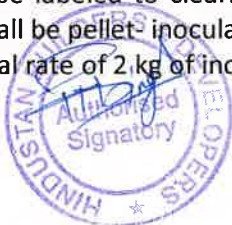

Chief Engineer
 Technical Cooperation Project
 Uttarakhand Forest Resource Management Project
 NTFP Centre, 49, IT Park
 Dehradun-248001

- e) Hydroseeding mulch mixture shall be applied so that seeds and soil are completely covered and there are no visible signs of soil or seeds exposed. The mulch mixture shall be applied at a rate that covers a minimum of 85% of the soil surface. Slurry shall be applied so that it does not run off the soil or down the slope.
- f) Fertilizer shall be pelleted, granular or soluble form.
- g) Follow-up applications shall be made as needed to cover weak spots and to maintain adequate soil protection.
- h) Over-spray onto the travel way, sidewalks, lined drainage channels and existing vegetation shall be avoided.

7.5. Maintenance and Inspection

- a) Conduct inspections as required.
- b) All seeded areas shall be re-seeded, fertilized and mulched within the planting season, using not less than half the original application rates. Any temporary revegetation efforts that do not provide adequate cover must be reapplied as required.
- c) The Firm is responsible for maintaining all slopes to prevent erosion.

7.6 Measurement and payment

Measurement

The work shall be measured in area which covered by the Hydroseeding.

Payment

The area of the work measure as above shall be paid in the Contract unit rate. The unit shall be full compensation for all associated accessories, equipment, labour, safety measures, materials etc.

8. COVERING/SLOPE PROTECTION WORK

COVERING WORK

8.1 Description

The covering/slope protection work is applied to prevent ground surface erosion/rockfall by rainfall and frost heaving, and to induce re-vegetation by improvement of circumstance for germination and growth species. This work shall consist of procurement, delivery of materials of covering work and laying of rockfall netting which is specified in this specification.

8.2 Material

(i) Slope protection netting

The rockfall netting shall be mechanically woven Double Twisted Hexagonal wire mesh (confirming to IS 16014), of galvanized (confirming to IS 4826) steel having mesh opening 100mmx120mm and mesh wire diameter 3 mm having tensile strength (confirming to IS 280) for slope protection netting.



[Handwritten Signature]
Chief Engineer
 Technical Cooperation Project
 Uttarakhand Forest Resource Management Project
 NTFP Centre, 49, IT Park
 Dehradun-248001

Requirement of the Slope protection netMesh Type and Sizes

Mesh Type	'D' Nominal Size (mm)	Tolerances
10 x 12	100	+16% to -4%

Mesh Characteristics

Mesh Type	10 x 12	Mass of Zinc coating, gms/m ²
'D' mm	100	
Wire Type	Zinc Coated	
Mesh Wire dia., mm	3.00	
Edge/selvedge wire dia., mm	3.90	280
Lacing wire dia., mm	2.20	240

Permitted tolerances on GI steel wire Diameters

Nominal diameter of galvanized wire, mm	Permitted tolerances (+/-) on wire diameters, mm
2.00	0.05
2.20	0.06
2.40	0.06
2.70	0.07
3.00	0.08
3.40	0.09
3.90	0.10

(ii) Main Anchor bolt and Sub Anchor bolt

Main Anchor and sub anchor bolt shall conform to FE500 or equivalent. High strength deformed steel bar should be used for main anchor and sub anchor bolt.

Required standard of Anchor bolt

Item	Tensile strength (N/sq.mm)	Yield point (N/sq.mm)	Reference
High strength deformed steel bar	more than 545	500	FE 500 IS 1786

Requirements of Main Anchor and sub anchor bolt

Item	Diameter (mm)	Total Length (mm)	Depth of Drilling (32mm dia.) (mm)
Main anchor bolt	20	500	450
Sub anchor bolt	16	400	350



[Signature]
Chief Engineer
 Technical Cooperation Project
 Uttarakhand Forest Resource Management Project
 NTFP Centre, 49, IT Park,
 Dehradun-248001

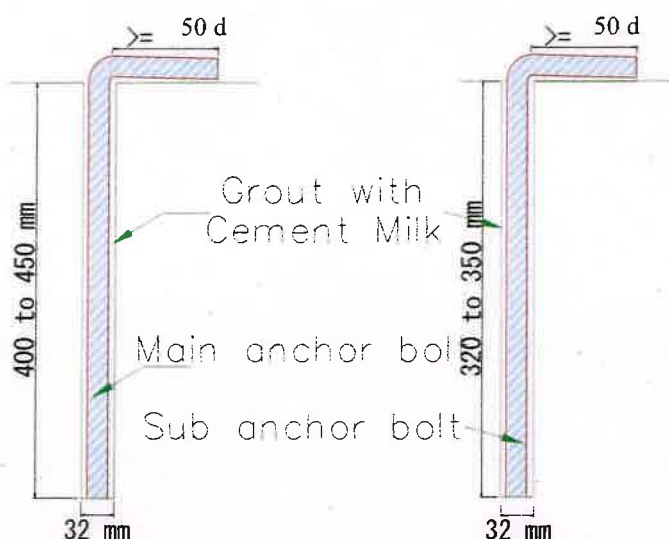

8.3. Construction requirement

8.3.1. Method Statements, Working Drawings/ Shop Drawings

The Firm shall submit the Methods Statements, Working Drawing/ Shop Drawings to the UFRMP, for his approval. At least 28 days prior to the commencement of the relevant activity. UFRMP has the authority to relax or do away with this requirement, if he chooses to do so, on a written requires made by the Firm.

The above documents shall clearly spell out the method the Firm proposes to carry out the construction / fabrication of the Permanent Works and Temporary work, if necessary. They shall also further give details of safety measures and the equipment and personnel to be deployed to carry out this work. No payment will be made for preparing the above documents.

8.3.2. Drilling

- (i) Drilling machine used shall be rotary type drilling machine or equivalent drilling machine, considering soil properties, ground condition, design requirements, and the site condition. Diameter of drilling shall be selected based on the requirements shown in the Drawings. Drilling methods including type of drilling machine, diameter of drilling, drilling positions and direction of drilling shall be including in the Method Statements.
- (ii) In order to ensure the correct depth of drilling is measured, the Firm shall take photos of the borehole after completion of the drilling as evidence. The photo shall show the borehole with inserting anchor bolt, the Firm's supervisor and slip mentioned borehole depth calculated by number and length of the used drilling rods.

The Firm shall inform the UFRMP, whenever he completes the drilling of each hole and shall not commence the installation of the anchor bolt without the approval of the UFRMP.

8.3.3. Installation of Anchor bolt

- (i) The Firm's shall clearly spell out the method and order for installing the anchor bolt into the borehole: such as 1) drilling, 2) clearing inside the hole, 3) inserting mortar cement into the borehole, inserting an anchor bolt and so on.



Chief Engineer
 Technical Cooperation Project
 Uttarakhand Forest Resource Management Project
 NTFP Centre, 49, IT Park
 Dehradun-248001

- ii) The Firm shall notify UFRMP of the completion of the installation of the rock bolt into the borehole, for its approval.

8.3.4. Laying and fixing of slope protection netting

- (i) The slope protection net shall be laid from the top of the target slope. The edge of the net shall be fixed along the top of the slope with main anchor bolt and sub anchor bolt.
- (ii) The slope protection net shall be rolled down gently without causing strong tensions from their own weight. The net shall be made close contact with the slope surface without any gaps between them. The net on uneven part
- (iii) The slope protection netting shall be fixed with main anchor bolt and sub anchor bolt in the specified arrangement shown below.
- (iv) In order to make close contacts between the slope protection net and the ground, concave/depression areas shall be selected on a slope at first and then the net shall be fixed with anchor bolts from there. Afterwards the net shall be fixed at surrounding areas of the concave/depression areas.

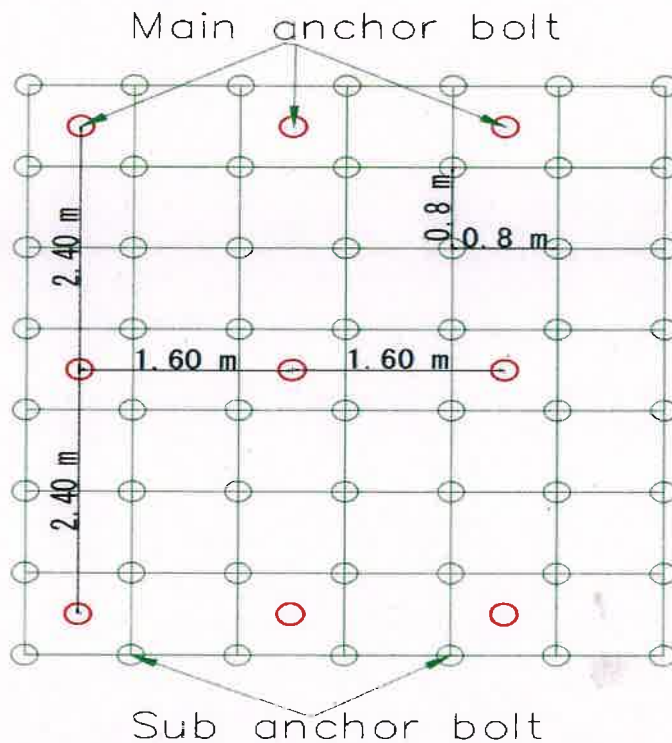

8.3.5 Measurement and payment

(i) Measurement

The work shall be measured in area which covered by the Rockfall Protection Netting.

(ii) Payment

The area of the work measure as above shall be paid in the Contract unit rate. The unit shall be full compensation for all labour, equipment, tools, safety measures, materials and accessories such as drilling, grout work, main anchor bolt and sub anchor bolt.



[Signature]
 Chief Engineer
 Technical Cooperation Project
 Uttarakhand Forest Resource Management Project
 NTFP Centre, 49, IT Park
 Dehradun-248001

9. SEEDING AND MULCHING

9.1. Scope

This shall consist of preparing slopes, placing topsoil, furnishing all seeds, commercial or organic fertilizers and mulching materials, providing coir netting and placing and incorporating the same on embankment slopes or other locations shown in the Drawings or as directed by the UFRMP.

For the information of grass seeds of the endemic species in Uttarakhand, the following species are listed: *Eulaliopsis binate*, *Cymbopogon jwarancusa*, *Bothriochloa pertusa*, *Chrysopogon fulvus*, *Heteropogon contortus*, *Panicum orientale*, *Themeda anathera*

As seeds of shrub trees, the following species are also listed:

Berberis lycium, *Colebrookia oppositifolia*, *Daphne oleoides*, *Desmodium tiliaefolium*, *Indigofera gerardiana*, *Indigofera pulchella*, *Myrsine africana*, *Prinsepia utilis*, *Punica granatum*, *Rhus cotinus*, *Woodfordia fruticosa*

9.2. Materials

9.2.1 Seeds

The seeds shall be of approved quality and type suitable for the soil on which these are to be applied and shall give acceptable purity and germination to requirements set down by the UFRMP.

Fertilizers shall consist of standard commercial materials and conform to the grade specified. Organic manure shall be fully putrefied organic matter such as cow dung.

Mulching materials shall consist of straw, hay, wood shavings or sawdust and shall be delivered in dry condition suitable for placing with a mulch blower. They shall be reasonably free of foreign materials as may detract from their effectiveness as mulch or be injurious to the plant growth.

9.2.2 Topsoil

Topsoil shall not be obtained from an area known to have noxious weeds growing in it. If treated with herbicide or sterilant, it shall be got tested by appropriate agricultural authority to determine the residual in the soil. Topsoil shall not contain less than 2 % and more than 12 % organic matters.

9.2.3 Mats

Erosion control biological mat manufactured from 100% coconut fiber. It is a woven type biodegradable erosion control blanket comprising of coconut braids having diameter of 3 to 6 mm. the coir fiber can retain moisture providing ideal germination conditions while protecting soil from erosion.



[Signature]
 Chief Engineer
 Technical Cooperation Project
 Uttarakhand Forest Resource Management Project
 NTFP Centre, 49, IT Park
 Dehradun-248001

Requirement of the mat

	Mass per unit area (g/m ²)	Tensile strength dry (longitudinal direction) KN/m	Tensile strength wet (longitudinal direction) KN/m	Tensile strength dry (Transverse direction) KN/m	Tensile strength wet (Transverse direction) KN/m
Test Standard	IS 15868	IS 13162	IS 13162	IS 13162	IS 13162
Mat Type	400	7	3	4	2
	700	8.5	7	8	4.5

9.3 Seeding Operations

After preparing slopes for seeding and mat covering, seeds of grasses and shrub trees shall be mixed with top soil, organic manures, mulching materials and water. Then the mixed seeding materials shall be evenly pasted on the slopes manually. The volumes and rates of the mixed seeding materials are as follow:

Materials	Grass seeds	Shrub tree seeds	Top soil	Organic manures	Mulching materials	Water
Volumes	50 g/m ²	10 g/ m ²	5 L/ m ²	3 L/ m ²	3 L/ m ²	10 L/ m ²

9.4 Coir Mat Covering Operation

Immediately after the mixed seeding materials are placed on the slopes, coir mats shall be unrolled to cover the pasted seeding materials and placed parallel to the flow of water immediately following the bringing, to finished grade, the area specified on the drawings. Where more than one strip is required to cover the given areas, they shall overlap a minimum of 100mm. Coir mat shall be held in place by approved wire staples, pins, spikes or wooden stakes driven vertically into the soil. The mats shall be placed carefully on the slopes without any spaces/gaps between the mats and slope ground surface.

After placing the Coir mats, 5 to 10 liters of water shall be placed on the mats to eliminate the gaps/spaces between the mats and the slope ground. At that time, it shall be observed carefully that mixed seeding materials are not flown away by the water.

9.5 Maintenance

The contractor shall maintain all seeded and mulched areas until final acceptance. Maintenance shall include protection of traffic by approved warning signs or barricades and repairing any areas damaged following the seeding and mulching operations. If mulched areas become damaged, the area shall be reshaped and then seeded and mulched again as originally specified.

9.6 Measurements of Payment

Seeding and mulching shall be measured as finished work in square meters.

9.7 Rate

The contract unit rate for seeding and mulching shall be payment in full for carrying out all the required operations including full compensation for all materials, labour, tools and incidentals.

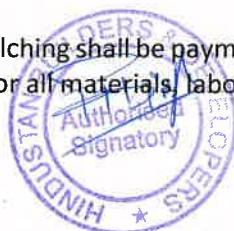

[Signature]
Chief Engineer
 Technical Cooperation Project
 Uttarakhand Forest Resource Management Project
 NTFP Centre, 49, IT Park
 Dehradun-248001

10. FENCE WORK

10.1. Description

The log fence work shall consist of procurement, delivery of materials of the work and construction of log fence work.

The work shall be carried out in accordance with the Specifications and lines, levels and grades, dimensions and cross-section shown in the Drawings or as directed by the UFRMP.

10.2. Material

(i) Wooden log

The wooden log to be used shall conform to the Drawings and this specification. The Requirements of the wooden log are as follows:

- a) The log shall be straight.
- b) The log with uniform overall diameter.
- c) The log with few nodes and unevenness.
- d) The log shall have antiseptic treatment.

Requirement of wooden log

Item	Diameter (mm)	Length (m)
Wooden log	100	2

(ii) Iron bar

Iron shall conform the Drawings and following standard.

Required standard of iron bar

Item	Length (m)	Diameter (mm)	Tensile strength (N/sq.mm)	Yield point (N/sq.mm)	Reference
High strength deformed steel bar	1	32	more than 545	500	FE 500 IS 1786

(iii) Annealing wire

The wire shall be 2.6 mm diameter, and enough flexibility to bind the wooden log and iron bar.

10.3. Construction requirement

10.3.1. Method Statements, Working Drawings / Shop Drawings

The Firm shall submit the Methods Statements, Working Drawing / Shop Drawings to the UFRMP, for his approval. At least 28 days prior to the commencement of the relevant activity. UFRMP has the authority to relax or do away with this requirement, if he chooses to do so, on a written requires made by the Firm.

The above documents shall clearly spell out the method the Firm proposes to carry out the construction / fabrication of the Permanent Works. They shall also further give details of safety



[Signature]
Chief Engineer

Technical Cooperation Project
Uttarakhand Forest Resource Management Project

measures and the equipment and personnel to be deployed to carry out this work. No payment will be made for preparing the above documents.

10.3.2. Clearing

The Firm shall clear a slope by hand. The Firm shall notify UFRMP of the completion of slope clearing for his approval.

10.3.3. Driving iron bar

The iron bar for fence post shall be driven on the ground perpendicularly until specified depth shown on the Drawings. If it is impossible to reach the specific depth, the Firm shall notify UFRMP to have UFRMP direction. The driving point of the iron bar shall be on the line of same level and specified interval shown on the Drawings.

10.3.4. Setting and binding wooden log

Wooden log shall be built up behind the iron bar without clearance between the logs. The wooden log shall be bound with the iron bar by the annealing wire tightly.

10.3.5 Backfilling

Space behind the fence shall be backfilled by soil and compacted firmly.

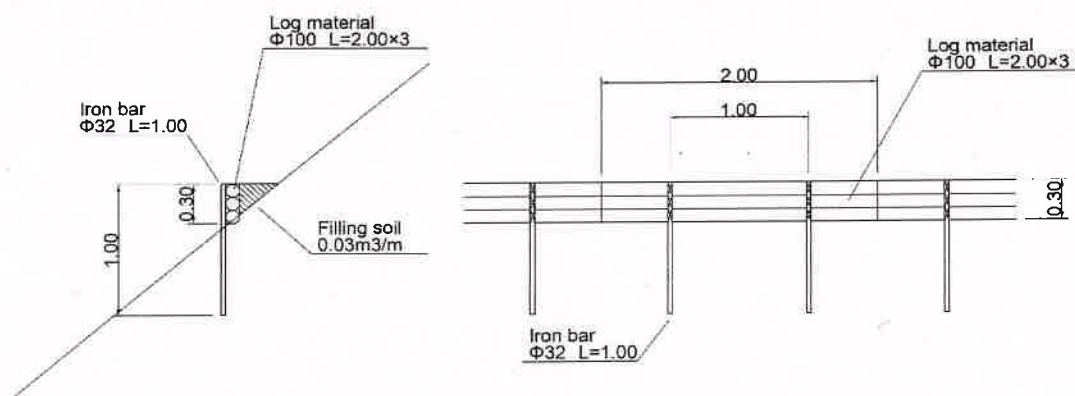

Fence work		Quantity of material per 10m	
Item	Standard	Quantity	unit
Log material	L=2.00m Φ0.1m	15.00	pc
Iron bar	L=1.00m Φ32mm	10.00	pc
Wire	Φ2.6mm	2.00	kg

10.4 Measurement and payment

(i) Measurement

Fence shall be measured in linear meters.



J. Shastri
Chief Engineer
 Technical Cooperation Project
 Uttarakhand Forest Resource Management Project
 NTFP Centre, 49, IT Park
 Dehradun-248001

(ii) Payment

The length of fence measured as above shall include all that has to be carried out to place the Fence work in place. The rates shall be full compensation for all labour, material, equipment and incidentals requirement to complete the work.

11. EROSION CONTROL MAT**11.1 Description**

The covering work is applied to prevent ground surface erosion by rainfall and frost heaving, and to induce re-vegetation by improvement of circumstance for germination and growth species. This work shall consist of procurement, delivery of materials of covering work and laying of erosion control mat which is specified in this specification.

11.2 Material**(i) Erosion control mat**

The erosion control mat shall be high porosity and non-woven fabric mat that will feature a random arrangement of water repellent ultra-fine fibers similar to the capillary roots on plants. The mat protects the soil from environmental changes (rain, wind, frost heaving, drought etc.). The inherent protection against erosion eliminates root swelling in exotic species that germinate and grow quickly. The green matting is therefore to applied with slow growing species.

The mat shall have enough experience to be applied to erosion control and re-vegetation work on forest slope, and conform to the Drawings and this specification.

Requirement of the erosion control mat

Type	Unit dimension (m)	Thickness (mm)	Unit weight (g/sq.m)	UV stability	Water holding capacity	Light penetration	C factor*
Erosion control mat	W1 × L20	≥ 2.0	≤ 100	90% for 500hr	≥ 2,000%	≥ 10%	≥ 0.2

*: Erosion control product factor (ASTM D6459)

(ii) Anchor pin and peg

Anchor pin and pegs shall conform to BS 4449 Grad 460 or equivalent. Galvanized coatings for anchor pin and pegs shall be conform to JIS H 8641 HDZ 45 or equivalent.

Requirements of anchor pin and peg

Item	Diameter (mm)	Length (mm)
Anchor pin	10	200
Peg	6	150

11.3. Construction requirement**11.3.1. Method Statements, Working Drawings/ Shop Drawings**

The Firm shall submit the Methods Statements, Working Drawing/ Shop Drawings to the UFRMP, for his approval. At least 28 days prior to the commencement of the relevant activity. UFRMP has the



Handwritten signature
Chief Engineer
 Technical Cooperation Project
 Uttarakhand Forest Resource Management Project
 NTFP Centre, 49, IT Park
 Dehradun-248001

authority to relax or do away with this requirement, if he chooses to do so, on a written requires made by the Firm.

The above documents shall clearly spell out the method the Firm proposes to carry out the construction / fabrication of the Permanent Works and Temporary work, if necessary. They shall also further give details of safety measures and the equipment and personnel to be deployed to carry out this work. No payment will be made for preparing the above documents.

11.3.2. Preparation of slope

(i) Trimming and clearing

The Firm shall trim and clear a slope by hand and/or construction machinery. Where water is encountered due to seepage, springs, and other reasons on a slope, the Firm shall take adequate measures after reporting to UFRMP for his direction. The Firm shall notify UFRMP of the completion of slope trimming and clearing for his approval.

(ii) Removal of Rock and Boulders

Unstable rocks on a slope shall be removed by hand as much as possible. Unstable rocks to be removed shall be selected based on the investigation mentioned in specifications and reported to UFRMP for his approval.

(iii) Removal of trees and shrubs

Trees and shrubs which may obstruct the work shall be removed prior to the commencement of the works. Trees and shrubs to be removed shall be selected by the Firm and approved by the UFRMP.

(iv) Disposal of surplus soil and removed trees and shrubs

Disposal method of surplus soil and removal of trees and shrubs shall conform to the Drawings, Specifications or the UFRMP's direction.

(v) Payment for slope trimming and clearing, removal of boulders and rock, removal of trees and shrubs, disposal of surplus soil, rock, boulders, trees and shrubs shall be deemed to be included in the unit rate for Crib rock, unless otherwise paid under other items.

12.3.3. Laying and fixing of erosion control mat

- (i) The mat shall be laid from the top of the target slope. The edge of the mat shall be fixed along the top of the slope with anchor pins and pegs. The edge of the mat shall be set 30 to 50cm behind a slope shoulder.
- (ii) The mat shall be rolled down gently without causing strong tensions from their own weight. The mat shall be made close contact with the slope surface without any gaps between them. The mat on uneven part only shall be installed additional pegs to make close contact.
- (iii) Overlapping width with lateral adjacent mat shall be approximately 3 cm, and with the maps on the up and down shall be approximately 5cm. The mats are overlaid as the lower side mat shall be below the upper side mat. Overlapping parts shall be fixed by the anchor pins and pegs.
- (iv) The mat shall be fixed with anchor pins and pegs in the specified arrangement shown below. If a channel or ditch are provided, the mat shall be placed up to the edges of the channel / ditch.
- (v) The mat shall be sprayed water to improve contact with the ground after laying.



Chief Engineer
 Technical Cooperation Project
 Uttarakhand Forest Resource Management Project
 NTFP Centre, 49, IT Park
 Dehradun-248001

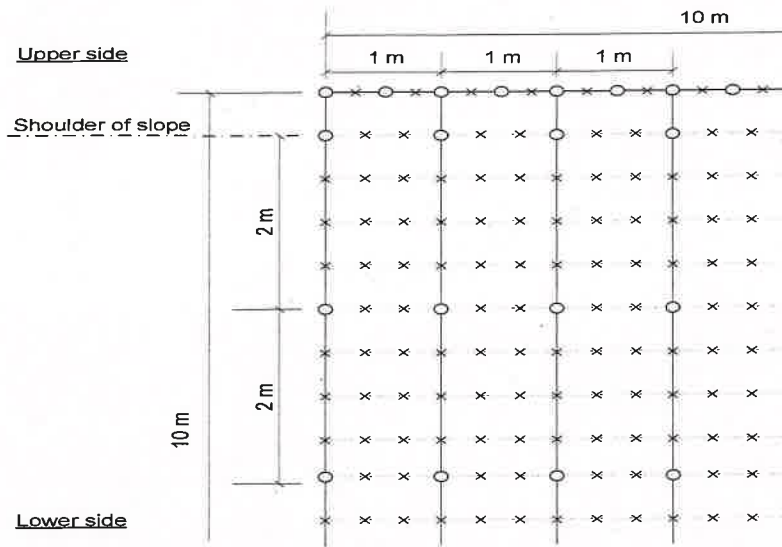

i. Measurement and payment

(i) Measurement

The work shall be measured in area which covered by the erosion control mat.

(ii) Payment

The area of the work measure as above shall be paid in the Contract unit rate. The unit shall be full compensation for all labour, equipment, tools, safety measures, materials and accessories such as anchor pins and pegs.



XXX

Chief Engineer
Technical Cooperation Project
Uttarakhand Forest Resource Management Project
NTFP Centre, 49, IT Park
Dehradun-248001



CLIENT:-	TECHNICAL COOPERATION PROJECT, UTTARAKHAND FOREST RESOURCE MANAGEMENT PROJECT, DEHRADUN			
TITLE:-	SITE PLAN			
PREPARED BY.	DB	20.06.2022		
CHECKED BY.	AR	25.06.2022		
APPROVED BY.	JKS	28.06.2022		
DR. NO:-	ML/SP/2021/1	REV.	0	
LOCATION:-	MALLA	SCALE:-	NTS.	

[Handwritten Signature]

Chief Engineer
Technical Cooperation Project
Uttarakhand Forest Resource Management Project
NTFP Centre, 49, IT Park
Dehradun-248001



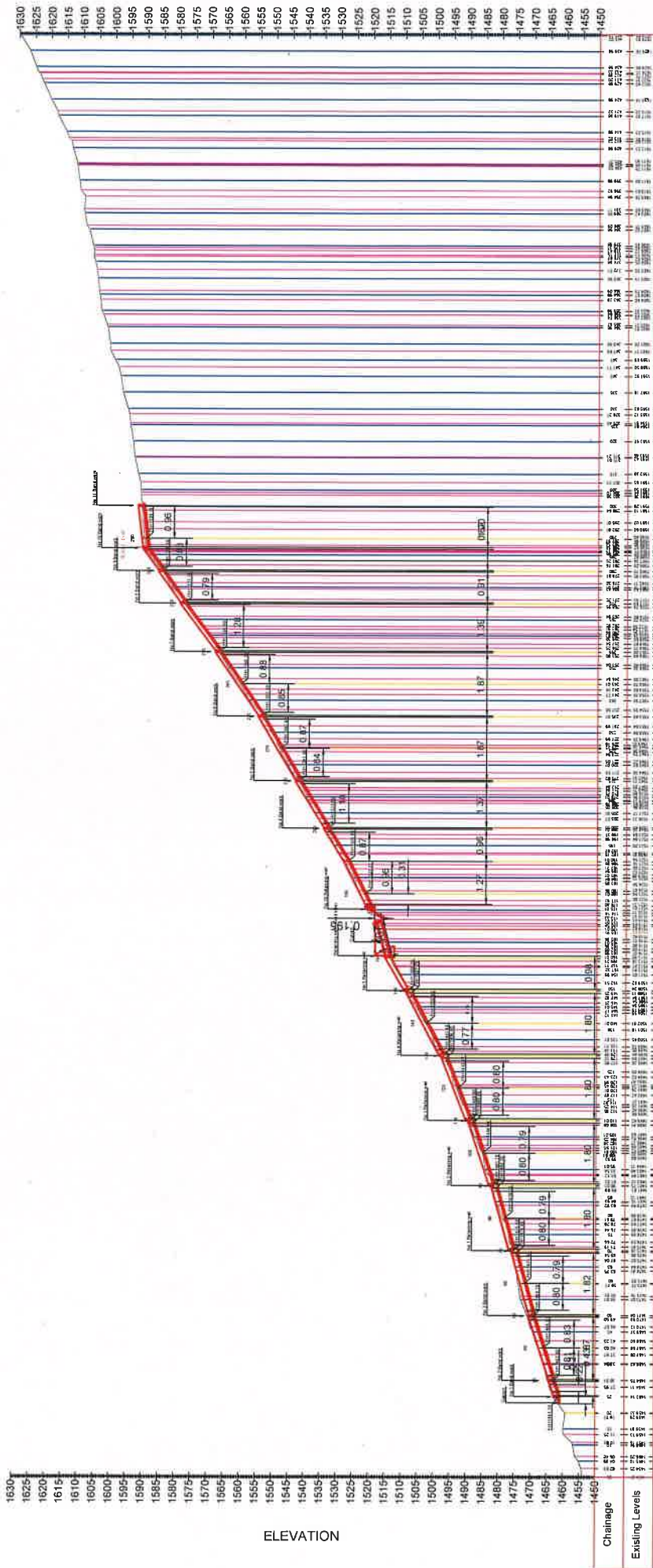

ELEVATION

Chainage

Existing Levels



[Signature]
Chief Engineer
 Technical Cooperation Project
 Uttarakhand Forest Resource Management Project
 NTFP Centre, 49, IT Park
 Dehradun-248001

CLIENT:-	TECHNICAL COOPERATION PROJECT, UTTARAKHAND FOREST RESOURCE MANAGEMENT PROJECT, DEHRADUN			
	TITLE:-	L-SECTION		
	PREPARED BY.	DB	20.06.2022	96 <i>[Signature]</i>
CHECKED BY.	AR	25.06.2022		
APPROVED BY.	JKS	28.06.2022		
DR. NO:-	ML/LS/2021/2	REV.	0	
LOCATION:-	MALLA	SCALE:-	NTS.	

Fence work

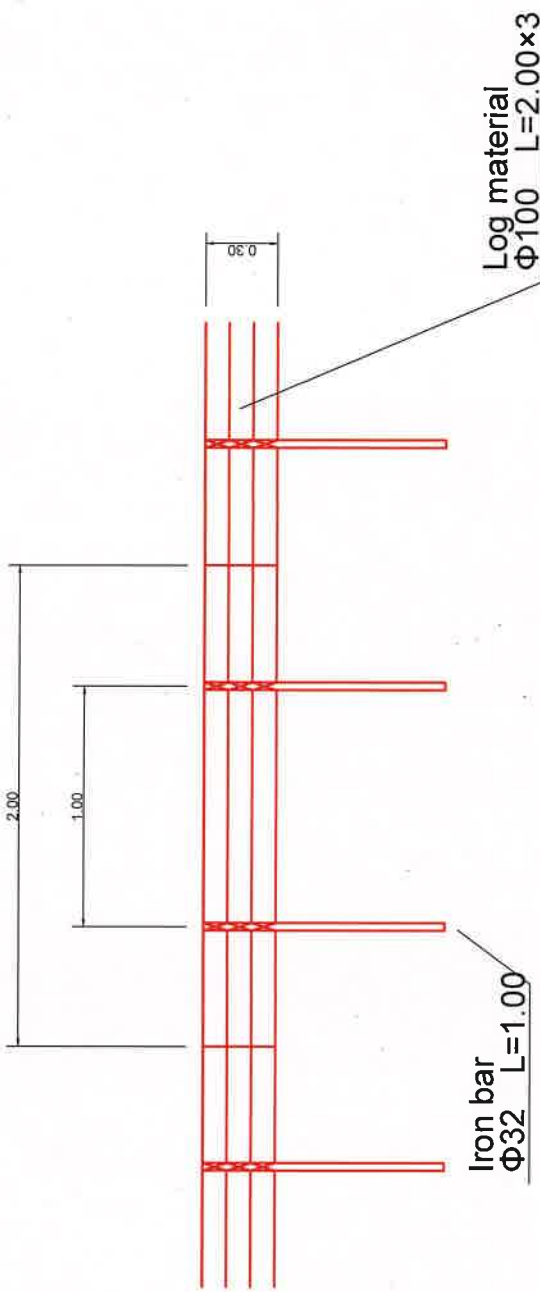
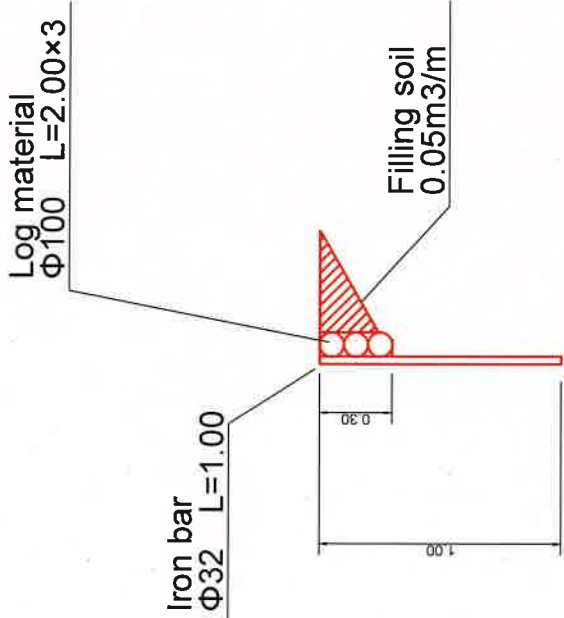

[Signature]
Chief Engineer
 Technical Cooperation Project
 Uttarakhand Forest Resource Management Project
 NTFP Centre, 49, IT Park
 Dehradun-248001

CLIENT:-	TECHNICAL COOPERATION PROJECT, UTTARAKHAND FOREST RESOURCE MANAGEMENT PROJECT, DEHRADUN		
TITLE:-	FENCE WORK		
PREPARED BY.	DB	20.06.2022	97
CHECKED BY.	AR	25.06.2022	
APPROVED BY.	JKS	28.06.2022	
DR. NO:-	ML/FW/2021/3	REV.	0
LOCATION:-	MALLA	SCALE:-	NTS.

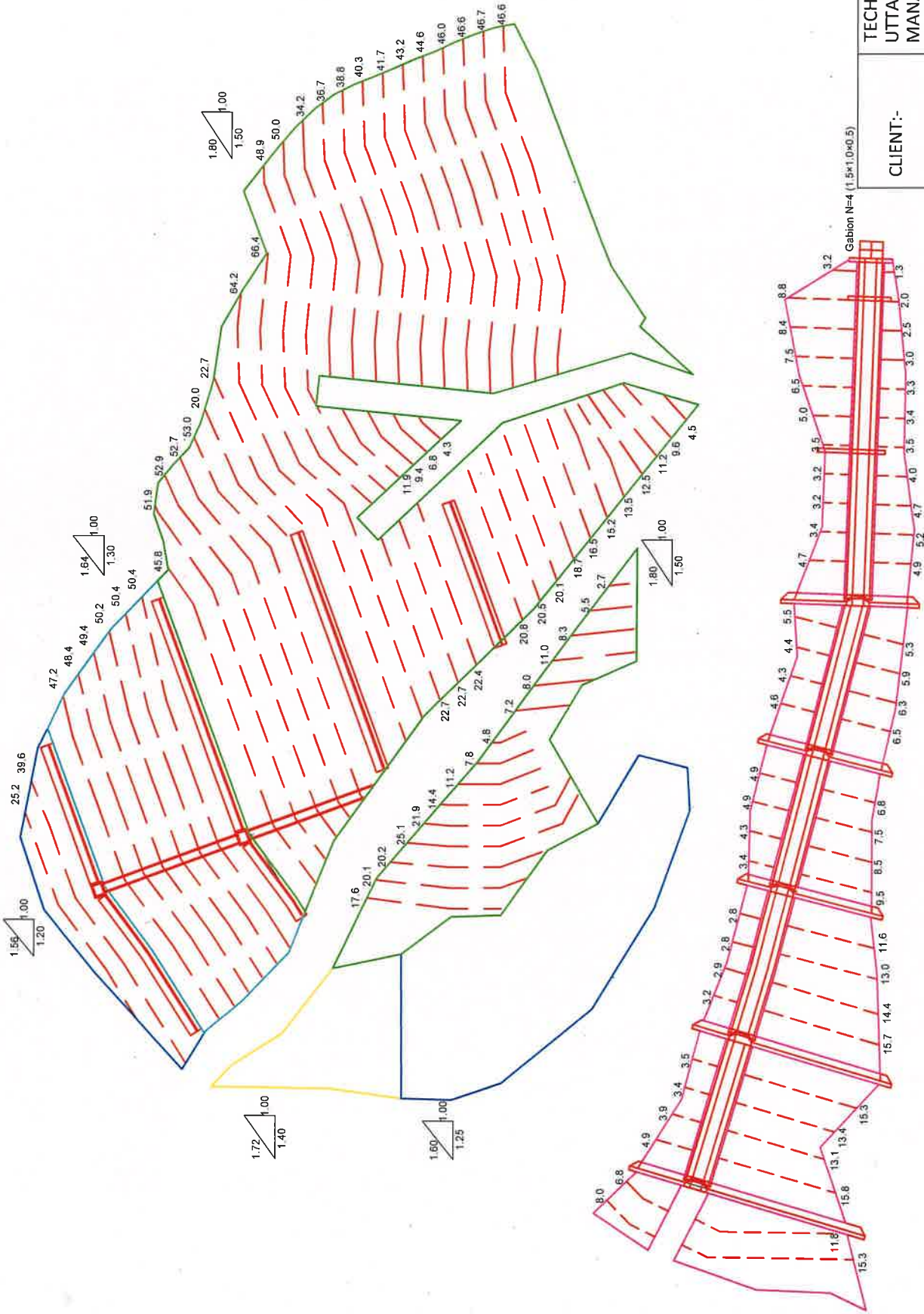

Gabion N-4 (1.5x1.0x0.5)

CLIENT:-	TECHNICAL COOPERATION PROJECT, UTTARAKHAND FOREST RESOURCE MANAGEMENT PROJECT, DEHRADUN			
TITLE:-	EROSION CONTROL MAT			
PREPARED BY.	DB	20.06.2022	98	
CHECKED BY.	AR	25.06.2022		
APPROVED BY.	JKS	28.06.2022		
DR. NO:-	ML/ECM/2021/4	REV.	0	
LOCATION:-	MALLA	SCALE:-	NTS.	

KS Sharma
Chief Engineer
 Technical Cooperation Project
 Uttarakhand Forest Resource Management Project
 NTFP Centre, 49, IT Park
 Dehradun-248001



CROSS SECTION AT CH. +290

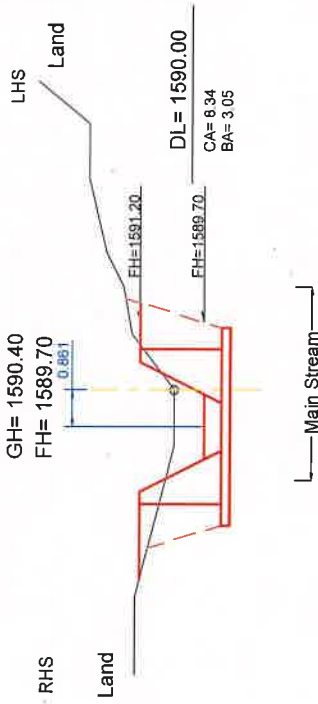

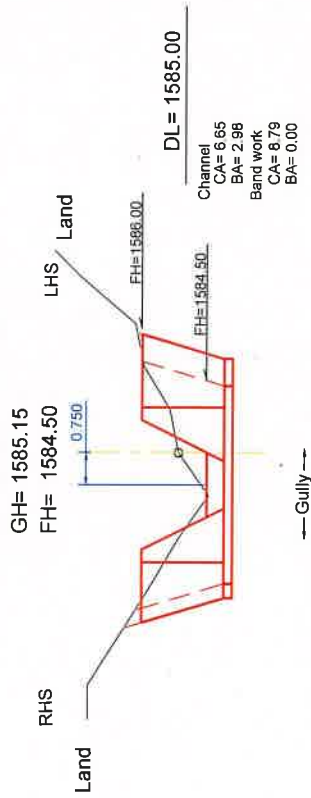

CROSS SECTION AT CH. +280

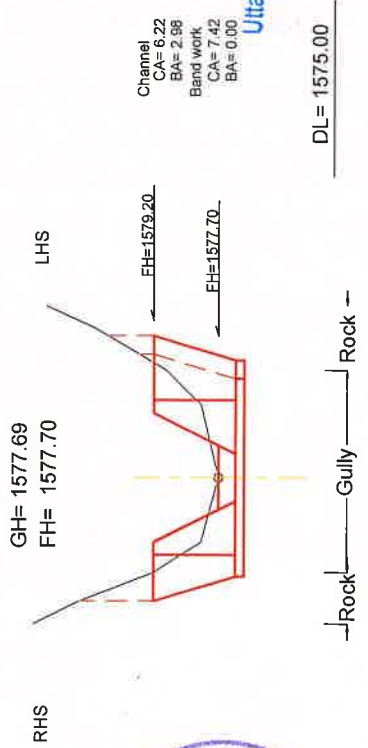

CROSS SECTION AT CH. +270





Chief Engineer
 Technical Cooperation Project
 Uttarakhand Forest Resource Management Project
 NTFP Centre, 49, IT Park
 Dehradun-248001

CLIENT:-	TECHNICAL COOPERATION PROJECT, UTTARAKHAND FOREST RESOURCE MANAGEMENT PROJECT, DEHRADUN		
TITLE:-	CHANNEL TYPE-1 X-SECTION & BAND WORK AT CH: 270,280,290		
PREPARED BY.	DB	20.06.2022	
CHECKED BY.	AR	25.06.2022	
APPROVED BY.	JKS	28.06.2022	
DR. NO:-	ML/CH/2021/5	REV.	0
LOCATION:-	MALLA	SCALE:-	NTS.

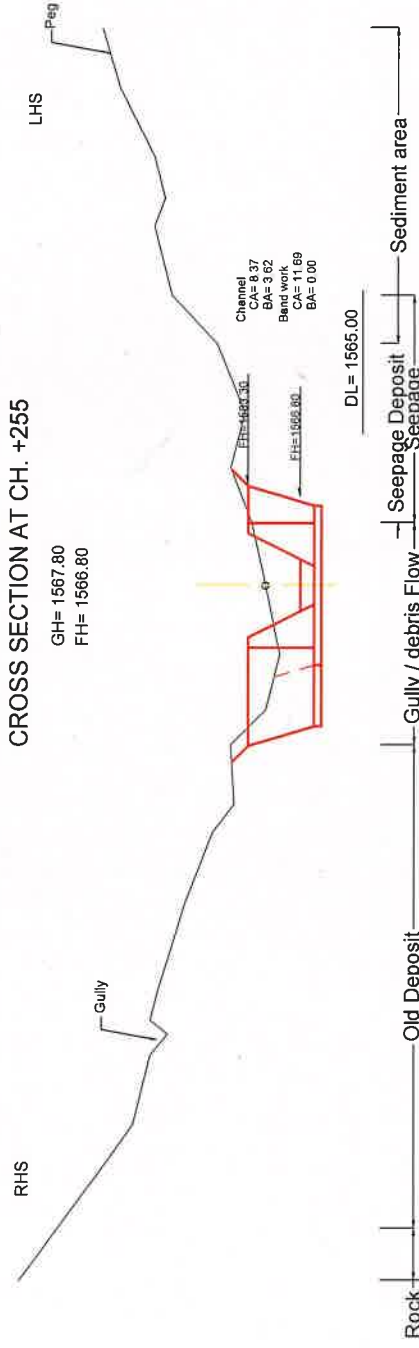

CROSS SECTION AT CH. +255

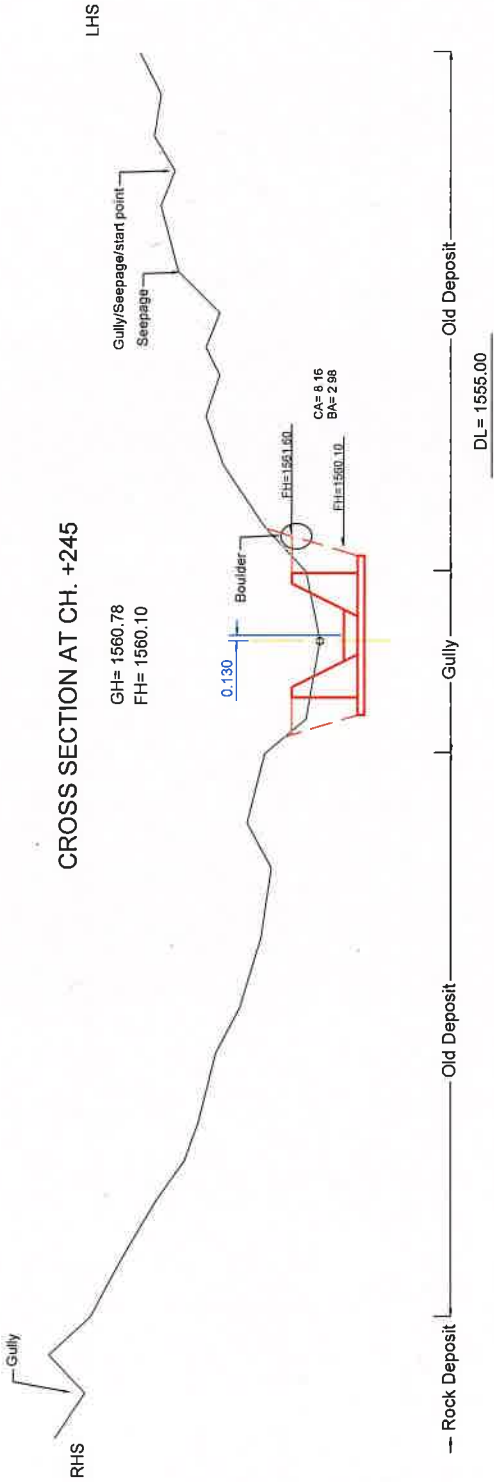

CROSS SECTION AT CH. +245



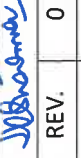

Chief Engineer
 Technical Cooperation Project
 Uttarakhand Forest Resource Management Project
 NTFP Centre, 49, IT Park
 Dehradun-248001

CLIENT:-	TECHNICAL COOPERATION PROJECT, UTTARAKHAND FOREST RESOURCE MANAGEMENT PROJECT, DEHRADUN			
TITLE:-	CHANNEL TYPE-1 X-SECTION & BAND WORK AT CH: 245,255			
PREPARED BY.	DB	20.06.2022		100
CHECKED BY.	AR	25.06.2022		
APPROVED BY.	JKS	28.06.2022		
DR. NO:-	ML/CH/2021/6	REV.	0	
LOCATION:-	MALLA	SCALE:-	NTS.	

CROSS SECTION AT CH. +235

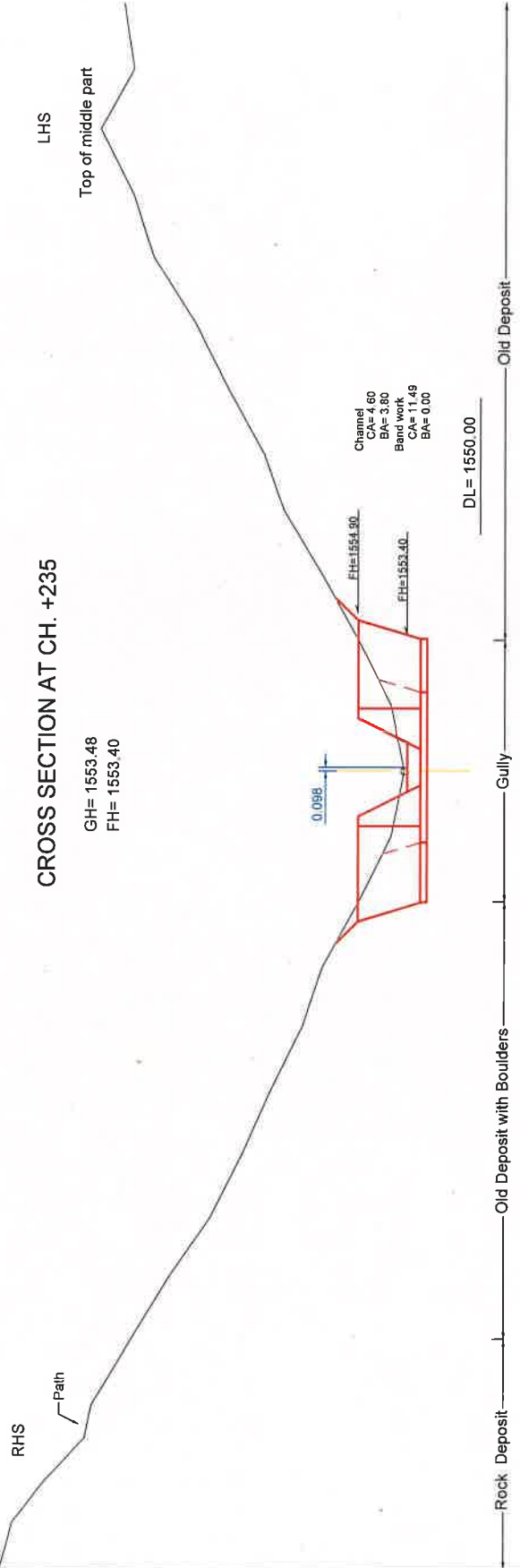
GH= 1553.48
FH= 1553.40



CROSS SECTION AT CH. +225

GH= 1548.08
FH= 1547.65

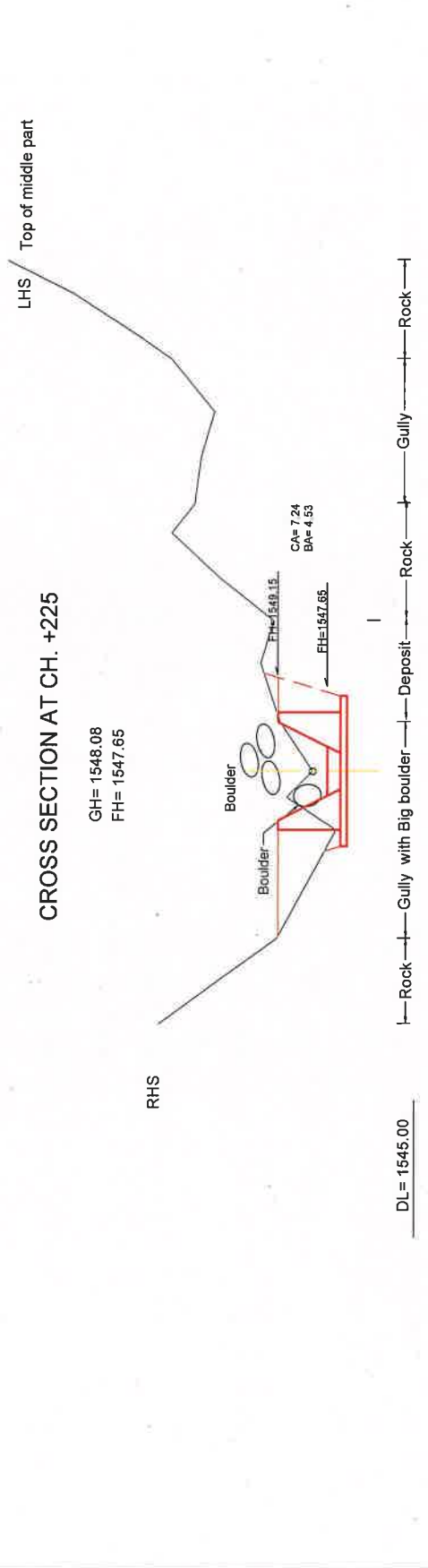

CLIENT:-	TECHNICAL COOPERATION PROJECT, UTTARAKHAND FOREST RESOURCE MANAGEMENT PROJECT, DEHRADUN			
TITLE:-	CHANNEL TYPE-1 X-SECTION & BAND WORK AT CH: 245,255			
PREPARED BY.	DB	20.06.2022	<i>[Signature]</i>	101
CHECKED BY.	AR	25.06.2022	<i>[Signature]</i>	101
APPROVED BY.	JKS	28.06.2022	<i>[Signature]</i>	
DR. NO:-	ML/CH/2021/7		REV.	0
LOCATION:-	MALLA		SCALE:-	NTS.



[Signature]
Chief Engineer
 Technical Cooperation Project
 Uttarakhand Forest Resource Management Project
 NTFP Centre, 49, IT Park
 Dehradun-248001

CROSS SECTION AT CH. +215

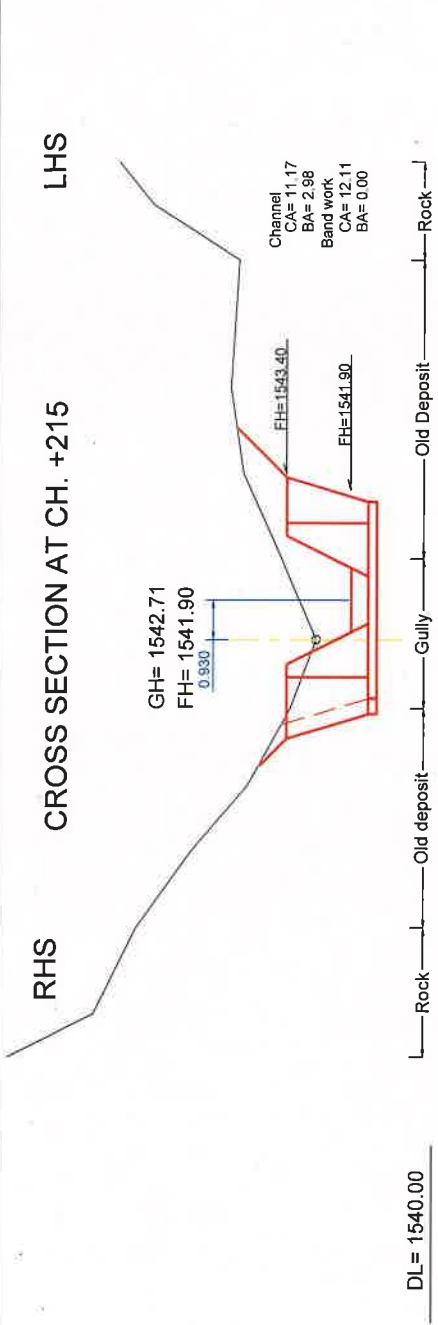

DL= 1540.00

CROSS SECTION AT CH. +200

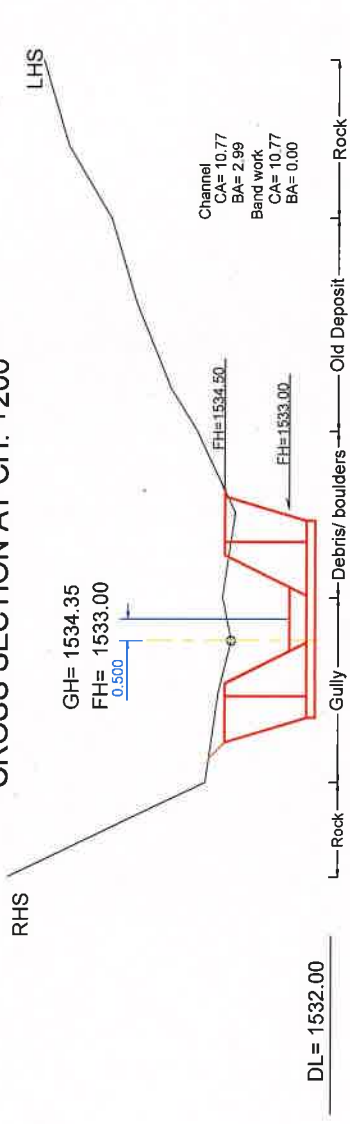

DL= 1532.00

CROSS SECTION AT CH. +190

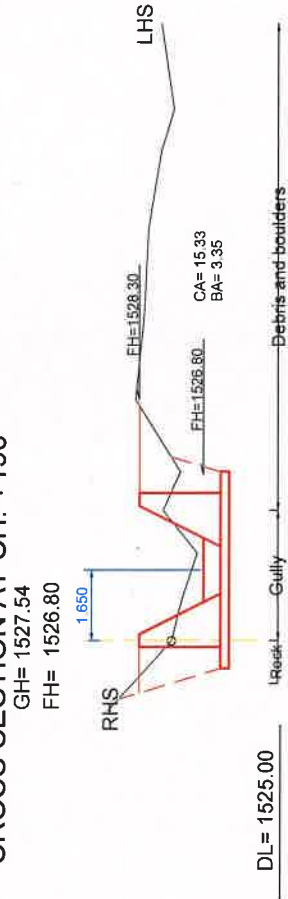

DL= 1525.00

CROSS SECTION AT CH+180

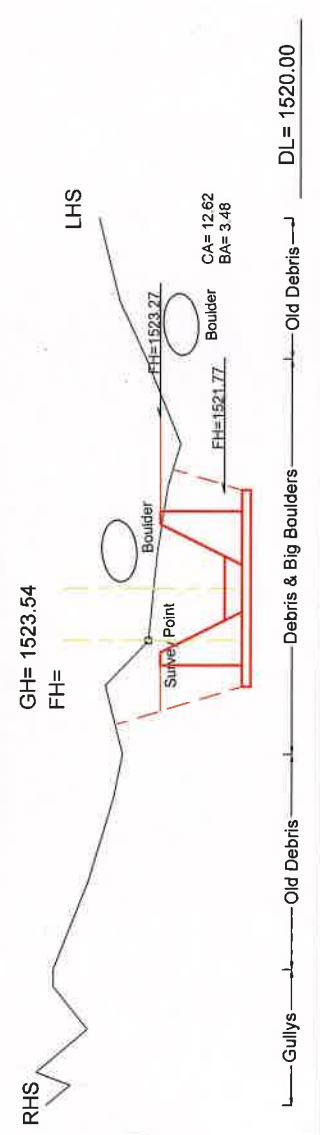

DL= 1520.00





 Chief Engineer
 Technical Cooperation Project
 Uttarakhand Forest Resource Management Project
 NTFP Centre, 49, IT Park
 Dehradun-248001

CLIENT:-	TECHNICAL COOPERATION PROJECT, UTTARAKHAND FOREST RESOURCE MANAGEMENT PROJECT, DEHRADUN		
TITLE:-	CHANNEL TYPE-1 X-SECTION & BAND WORK AT CH: 180,190,200,215		
PREPARED BY.	DB	20.06.2022	102
CHECKED BY.	AR	25.06.2022	
APPROVED BY.	JKS	28.06.2022	
DR. NO:-	ML/CH/2021/8	REV.	0
LOCATION:-	MALLA	SCALE:-	NTS.

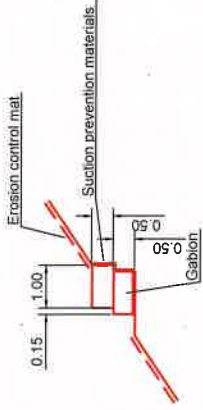
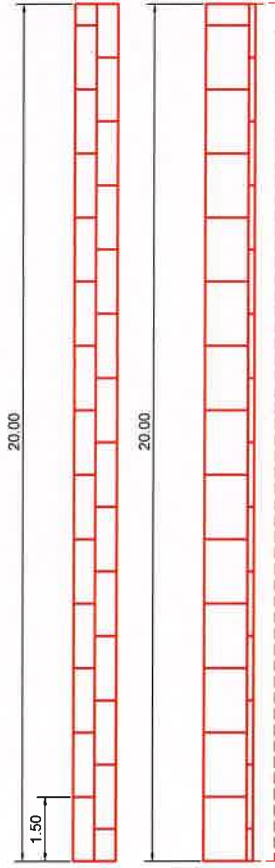
Retaining wall No.6

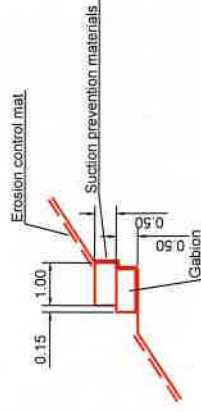
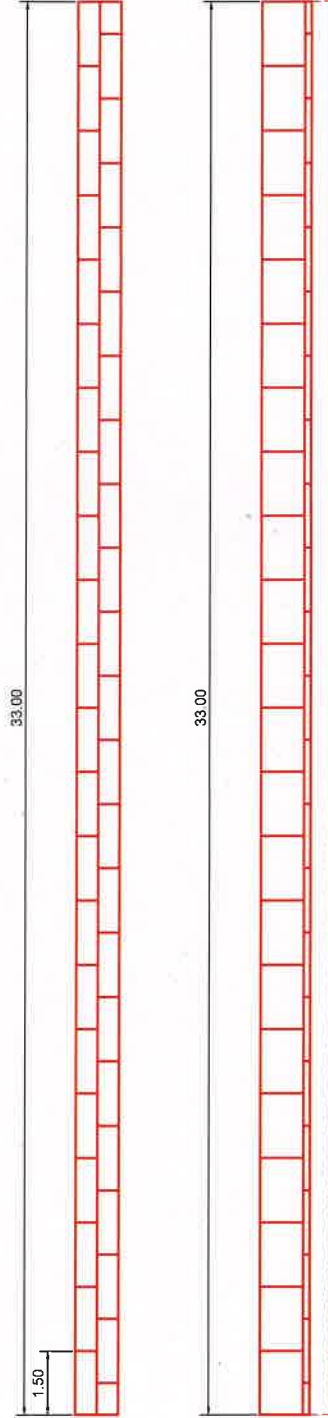

Retaining wall No.7



[Signature]
Chief Engineer
 Technical Cooperation Project
 Uttarakhand Forest Resource Management Project
 NTFP Centre, 49, IT Park
 Dehradun-248001

CLIENT:-	TECHNICAL COOPERATION PROJECT, UTTARAKHAND FOREST RESOURCE MANAGEMENT PROJECT, DEHRADUN			
TITLE:-	RETAINING WALL NO. 6 & 7			
PREPARED BY.	DB	20.06.2022	<i>[Signature]</i>	103
CHECKED BY.	AR	25.06.2022	<i>[Signature]</i>	
APPROVED BY.	JKS	28.06.2022	<i>[Signature]</i>	
DR. NO:-	ML/RW/2021/9	REV.	0	
LOCATION:-	MALLA			SCALE:- NTS.

Retaining wall No.8

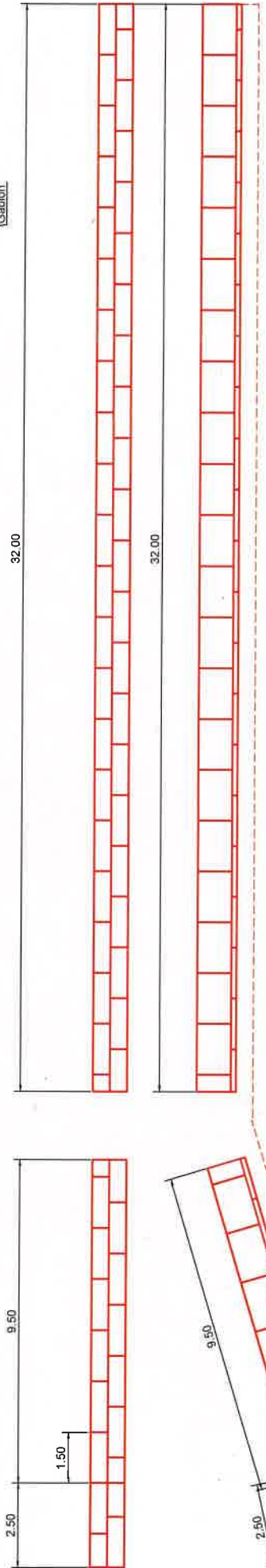

Retaining wall No.9

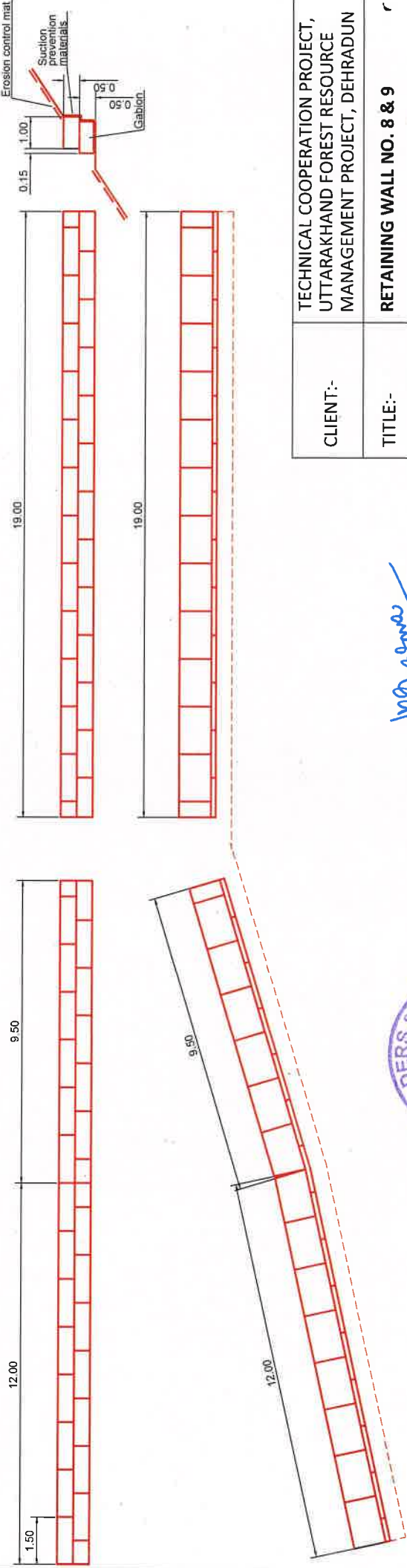

J. Sharma
Chief Engineer
 Technical Cooperation Project
 Uttarakhand Forest Resource Management Project
 NTFP Centre, 49, IT Park
 Dehradun-248001

CLIENT:-	TECHNICAL COOPERATION PROJECT, UTTARAKHAND FOREST RESOURCE MANAGEMENT PROJECT, DEHRADUN			
TITLE:-	RETAINING WALL NO. 8 & 9			
PREPARED BY:	DB	20.06.2022		
CHECKED BY:	AR	25.06.2022		
APPROVED BY:	JKS	28.06.2022		
DR. NO:-	ML/RW/2021/10	REV.	0	
LOCATION:-	MALLA	SCALE:-	NTS.	

Retaining wall No.10

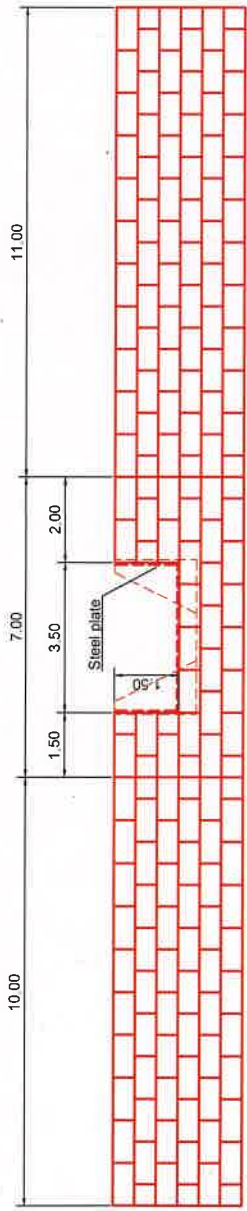

Gabion : $4.5m^2 \times (10.00+7.00+11.00) \times 2.25 \times 3.50 = 118.13m^3$
 Suction prevention materials: $5.25m \times (10.00+7.00+11.00) \times 1.80 \times 3.50 = 140.70m^3$

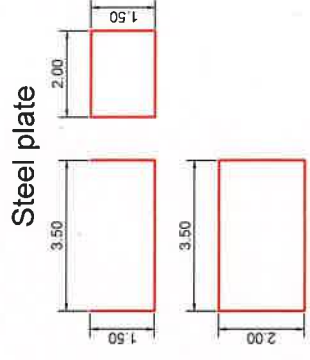
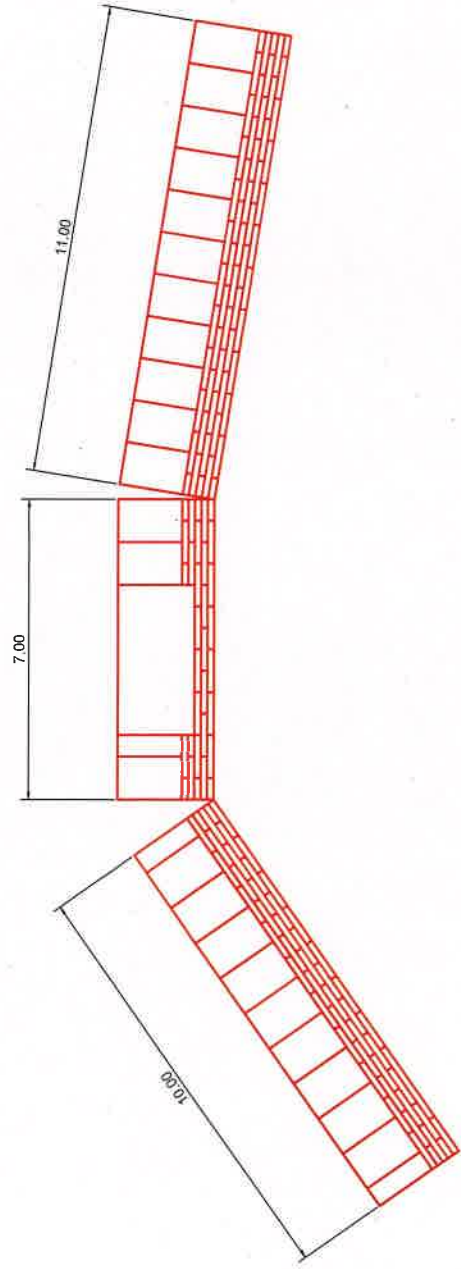
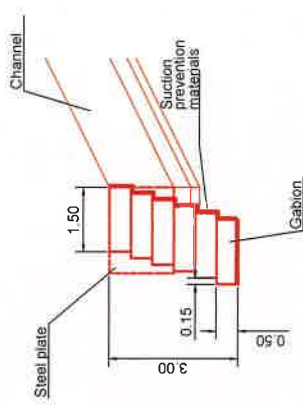

[Signature]
Chief Engineer
 Technical Cooperation Project
 Uttarakhand Forest Resource Management Project
 NTFP Centre, 49, IT Park
 Dehradun-248001

CLIENT:-	TECHNICAL COOPERATION PROJECT, UTTARAKHAND FOREST RESOURCE MANAGEMENT PROJECT, DEHRADUN		
TITLE:-	RETAINING WALL NO. 10		
PREPARED BY:	DB	20.06.2022	<i>[Signature]</i>
CHECKED BY:	AR	25.06.2022	
APPROVED BY:	JKS	28.06.2022	<i>[Signature]</i>
DR. NO:-	ML/RW/2021/11	REV.	0
LOCATION:-	MALLA	SCALE:-	NTS.

105

Channel work Type.1

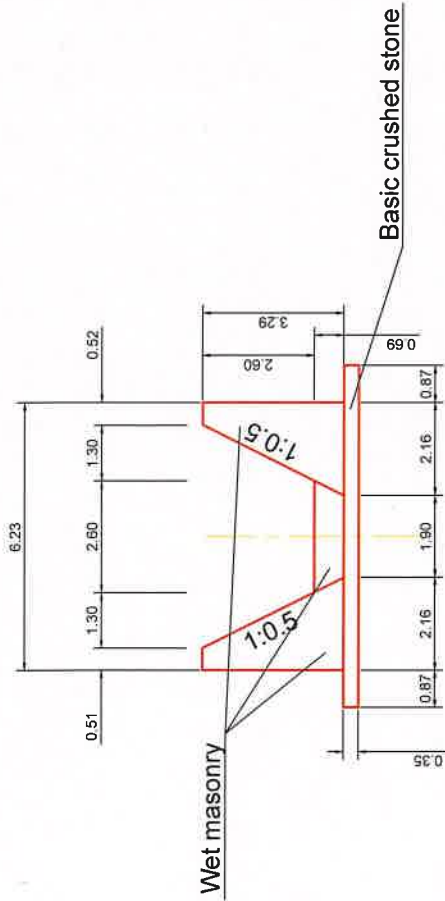

Channel work Type.2

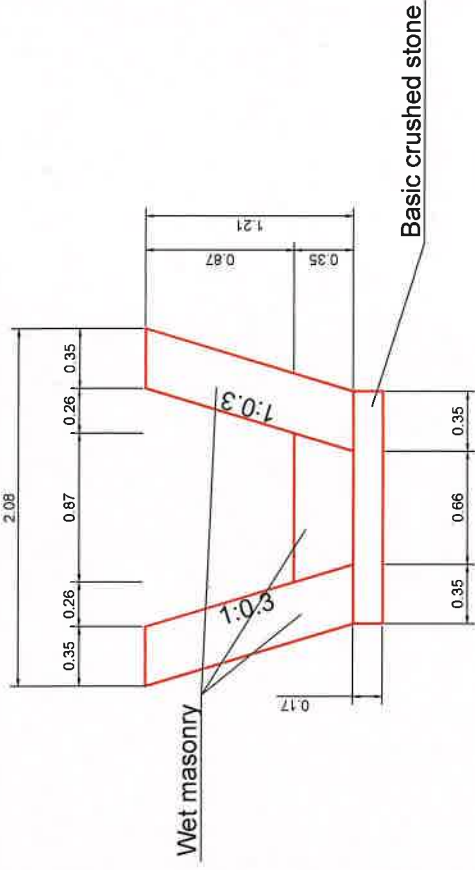

Channel Type.3

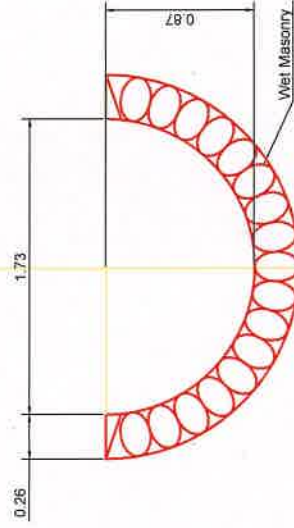

[Signature]
Chief Engineer
 Technical Cooperation Project
 Uttarakhand Forest Resource Management Project
 NTFP Centre, 49, IT Park
 Dehradun-248001

CLIENT:-	TECHNICAL COOPERATION PROJECT, UTTARAKHAND FOREST RESOURCE MANAGEMENT PROJECT, DEHRADUN		
TITLE:-	CHANNEL TYPE-1,2&3		
PREPARED BY.	DB	20.06.2022	<i>[Signature]</i>
CHECKED BY.	AR	25.06.2022	
APPROVED BY.	JKS	28.06.2022	
DR. NO:-	ML/CHT/2021/12	REV.	0
LOCATION:-	MALLA	SCALE:-	NTS.

106

Basin No.1

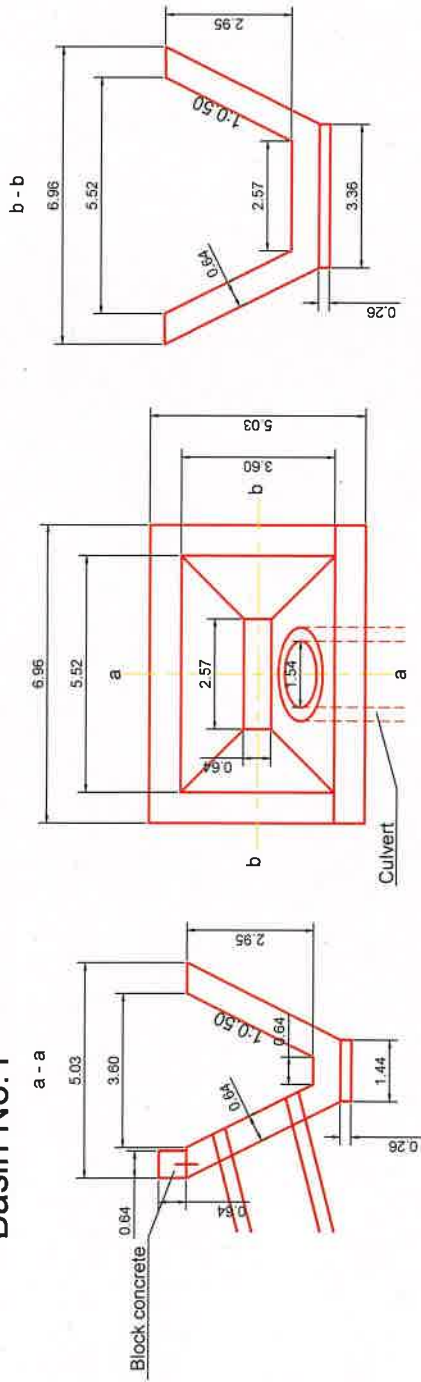

Basin No.2

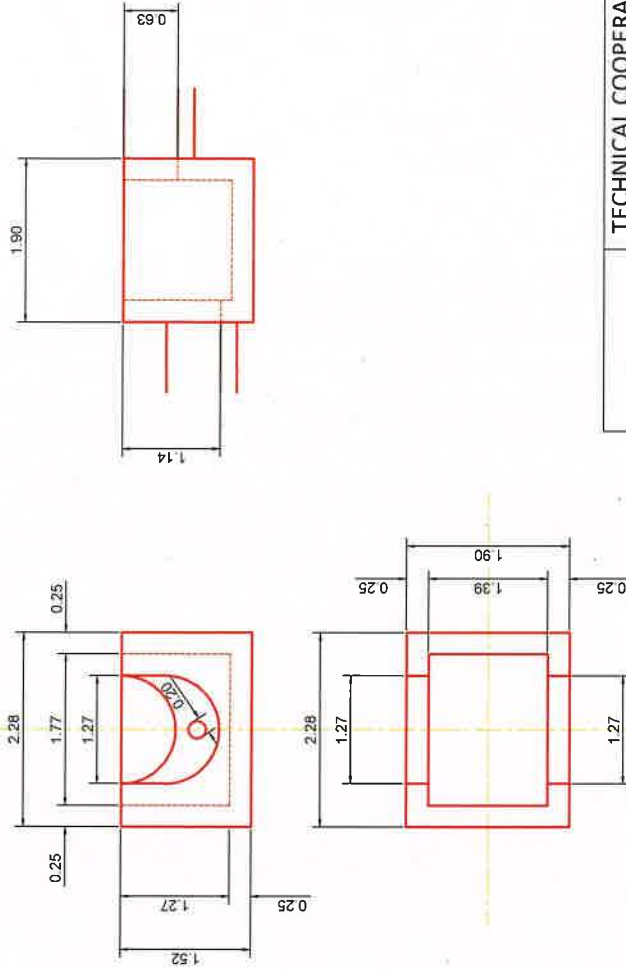

Basin No.3

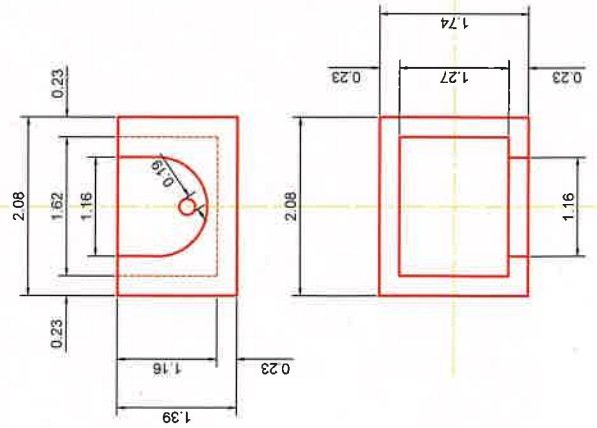

[Signature]
Chief Engineer
 Technical Cooperation Project
 Uttarakhand Forest Resource Management Project
 NTFP Centre, 49, IT Park
 Dehradun-248001



CLIENT:-	TECHNICAL COOPERATION PROJECT, UTTARAKHAND FOREST RESOURCE MANAGEMENT PROJECT, DEHRADUN		
TITLE:-	CATCH BASIN NO. 1,2 & 3		
PREPARED BY.	DB	20.06.2022	<i>[Signature]</i>
CHECKED BY.	AR	25.06.2022	
APPROVED BY.	JKS	28.06.2022	
DR. NO:-	ML/CB/2021/13	REV.	0
LOCATION:-	MALLA	SCALE:-	NTS.

107

CROSS SECTION AT CH-150

GH= 1508.24
FH= 1508.20



Upper
CA= 2.38
BA= 94.30
Under
CA= 7.45
BA= 23.70

DL= 1505.00

CROSS SECTION AT CH-140

GH= 1502.81
FH= 1502.40

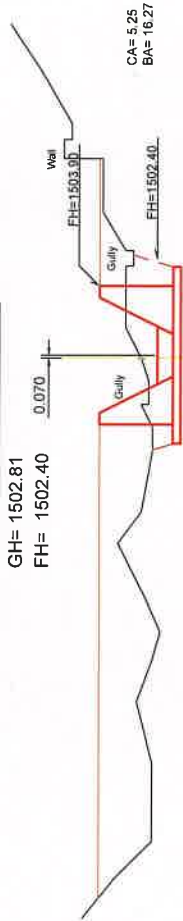

CA= 5.25
BA= 16.27

DL= 1500.00

CROSS SECTION AT CH-130

GH= 1498.44
FH= 1497.40

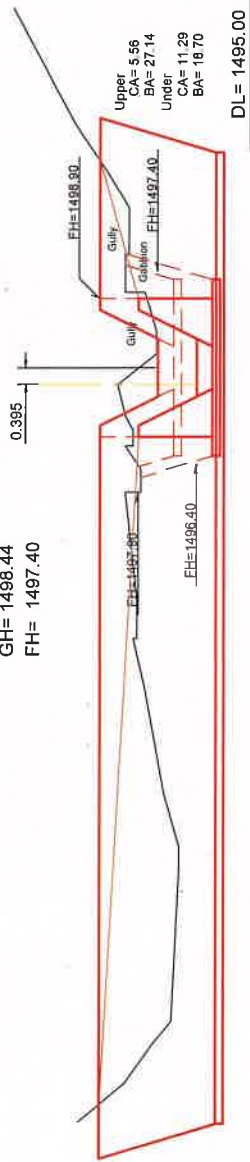

Upper
CA= 5.56
BA= 27.14
Under
CA= 11.29
BA= 18.70

DL= 1495.00

CLIENT:- TECHNICAL COOPERATION PROJECT,
UTTARAKHAND FOREST RESOURCE
MANAGEMENT PROJECT, DEHRADUN

TITLE:- X-SECTION RETAINING WALL NO. 4 & 5

PREPARED BY: DB 20.06.2022

CHECKED BY: AR 25.06.2022

APPROVED BY: JKS 28.06.2022

DR. NO:- ML/RW/2021/14 REV. 0

LOCATION:- MALLA SCALE:- NTS.



Chief Engineer
Technical Cooperation Project
Uttarakhand Forest Resource Management Project
NTP Centre, 49, IT Park
Dehradun-248001

CROSS SECTION AT CH-120

GH= 1493.26
FH= 1492.77

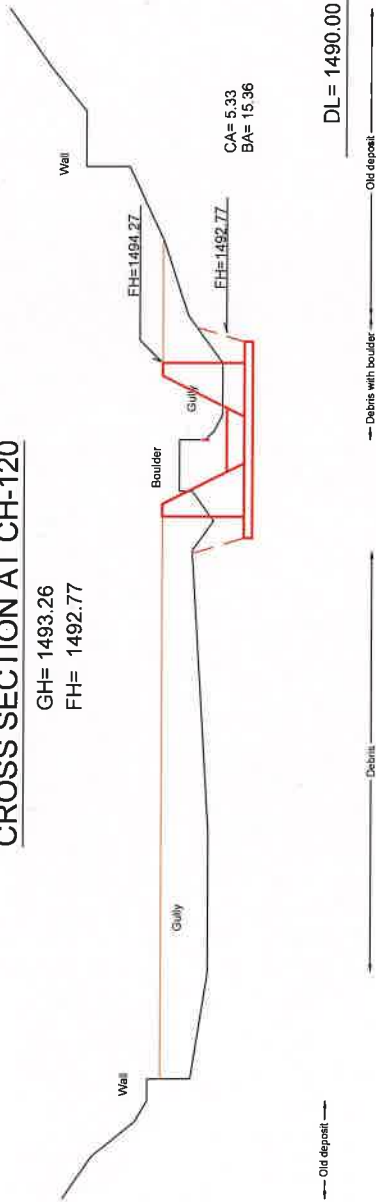

CA= 5.33
BA= 15.36

DL= 1490.00

CROSS SECTION AT CH-110

GH= 1489.42
FH= 1489.00

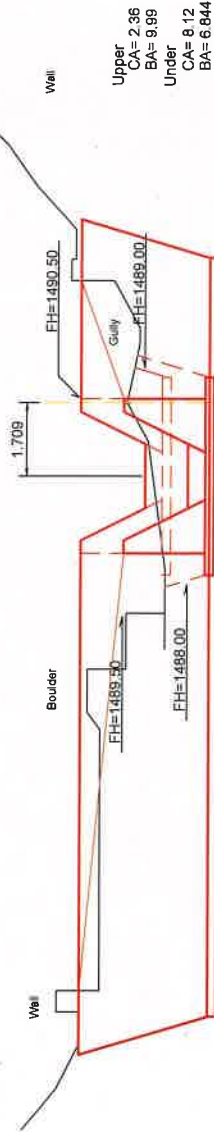

Upper
CA= 2.36
BA= 9.99
Under
CA= 8.12
BA= 6.844

DL= 1485.00

CROSS SECTION AT CH-100

GH= 1485.02
FH= 1484.89

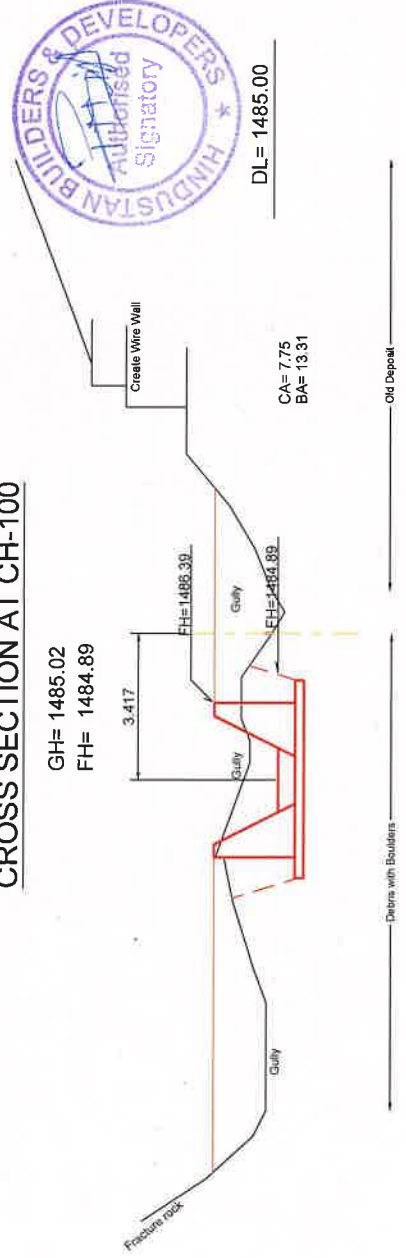

CA= 7.75
BA= 13.31

DL= 1485.00

[Signature]

Chief Engineer
Technical Cooperation Project
Uttarakhand Forest Resource Management Project
NTPF Centre, 49, IT Park
Dehradun-248001

CLIENT:-	TECHNICAL COOPERATION PROJECT, UTTARAKHAND FOREST RESOURCE MANAGEMENT PROJECT, DEHRADUN		
TITLE:-	X-SECTION RETAINING WALL NO. 3 AND CHANNEL WORK		
PREPARED BY.	DB	20.06.2022	<i>[Signature]</i>
CHECKED BY.	AR	25.06.2022	
APPROVED BY.	JKS	28.06.2022	
DR. NO:-	ML/RW/2021/15	REV.	0
LOCATION:-	MALLA	SCALE:-	NTS.



CROSS SECTION AT CH-90

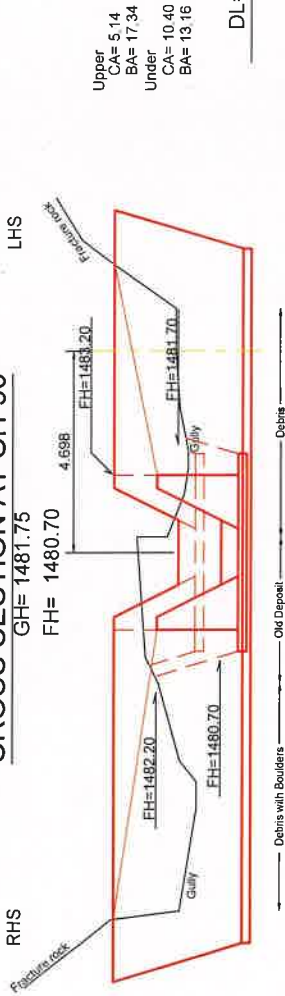

CROSS SECTION AT CH-80

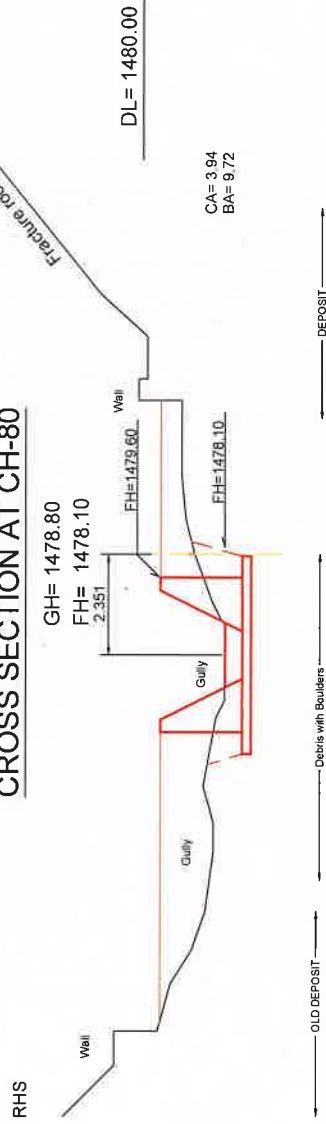

CROSS SECTION AT CH-70

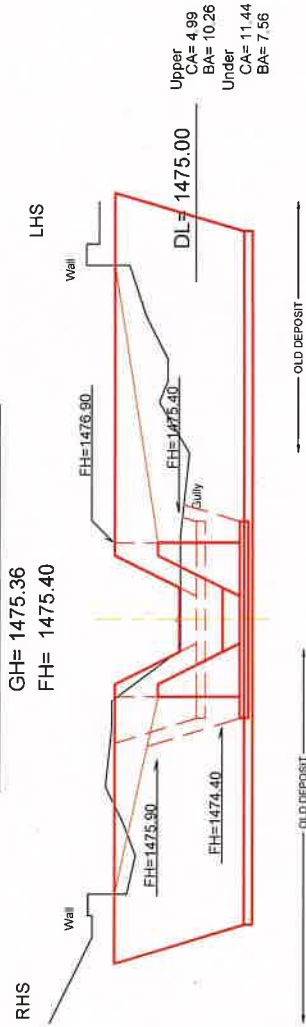

CROSS SECTION AT CH-60

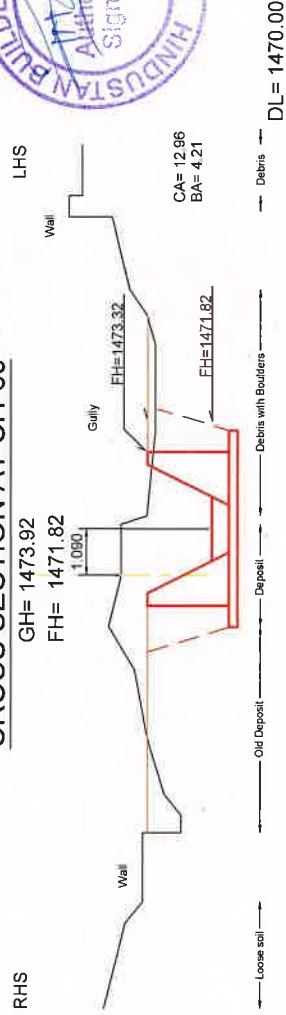



Chief Engineer
 Technical Cooperation Project
 Uttarakhand Forest Resource Management Project
 NTFP Centre, 49, IT Park
 Dehradun-248001

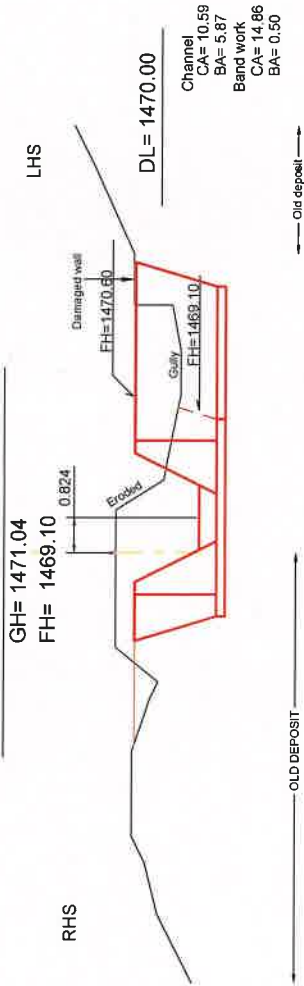

CLIENT:-	TECHNICAL COOPERATION PROJECT, UTTARAKHAND FOREST RESOURCE MANAGEMENT PROJECT, DEHRADUN			
TITLE:-	X-SECTION RETAINING WALL NO. 1,2 AND CHANNEL WORK			
PREPARED BY.	DB	20.06.2022		110
CHECKED BY.	AR	25.06.2022		
APPROVED BY.	JKS	28.06.2022		
DR. NO:-	ML/RW/2021/16	REV.	0	
LOCATION:-	MALLA	SCALE:-	NTS.	

CROSS SECTION AT CH-50



CROSS SECTION AT CH-40

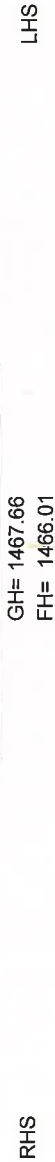

CROSS SECTION AT CH-30

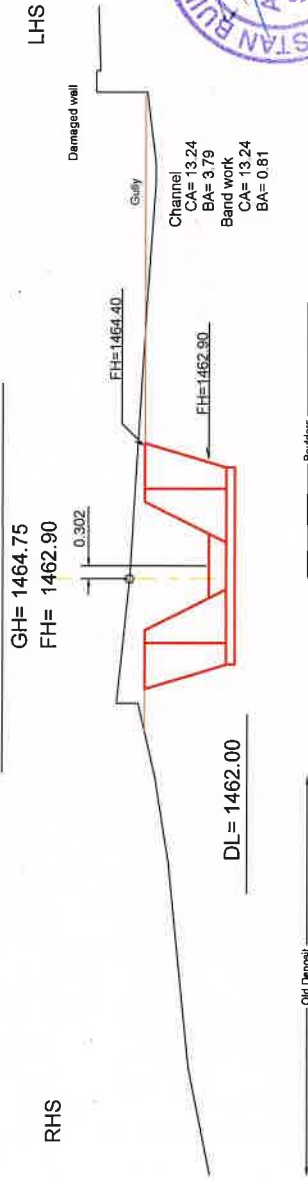

CROSS SECTION AT CH-20

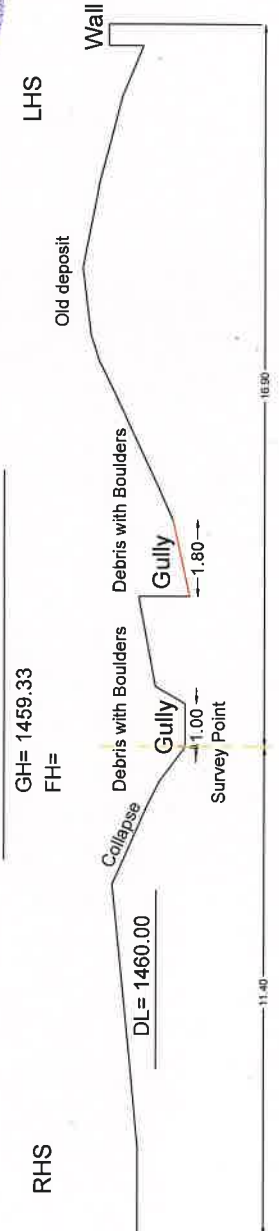



Chief Engineer
 Technical Cooperation Project
 NTFP Centre, 49, IT Park
 Dehradun-248001

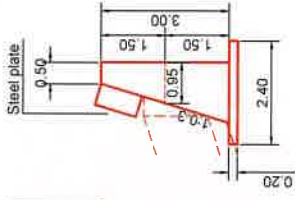
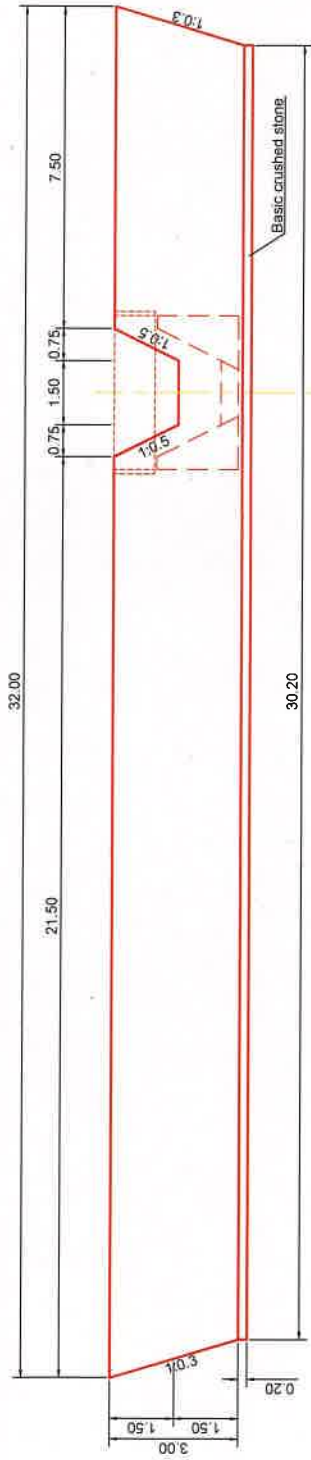

CLIENT:-	TECHNICAL COOPERATION PROJECT, UTTARAKHAND FOREST RESOURCE MANAGEMENT PROJECT, DEHRADUN			
TITLE:-	X-SECTION BAND WORK AND CHANNEL			
PREPARED BY.	DB	20.06.2022	  	0
CHECKED BY.	AR	25.06.2022		
APPROVED BY.	JKS	28.06.2022		
DR. NO.:-	ML/BW/2021/17		REVISION	0
LOCATION:-	MALLA		SCALE:-	NTS.

Retaining wall No.5



Steel plate

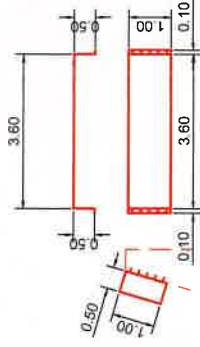
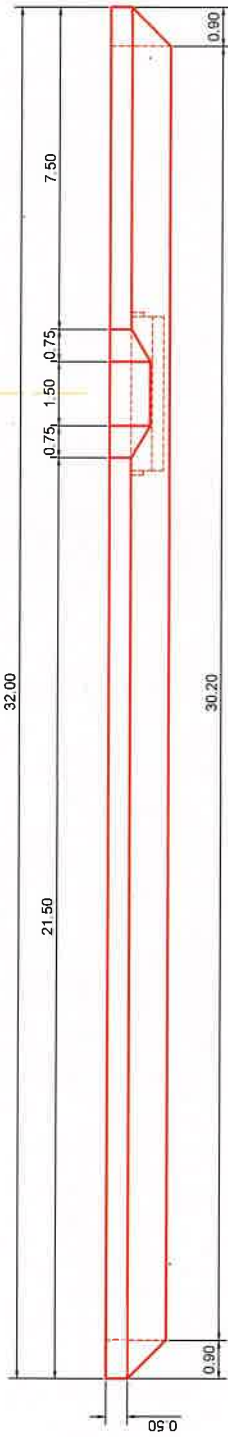

[Handwritten Signature]

Chief Engineer
 Technical Cooperation Project
 Uttarakhand Forest Resource Management Project
 NTFP Centre, 49, IT Park
 Dehradun-248001

CLIENT:-	TECHNICAL COOPERATION PROJECT, UTTARAKHAND FOREST RESOURCE MANAGEMENT PROJECT, DEHRADUN			
TITLE:-	RETAINING WALL NO.5			
PREPARED BY.	DB	20.06.2022		112
CHECKED BY.	AR	25.06.2022		
APPROVED BY.	JKS	28.06.2022		
DR. NO:-	ML/RW/2021/18	REV.	0	
LOCATION:-	MALLA		SCALE:-	NTS.

Retaining wall No.3

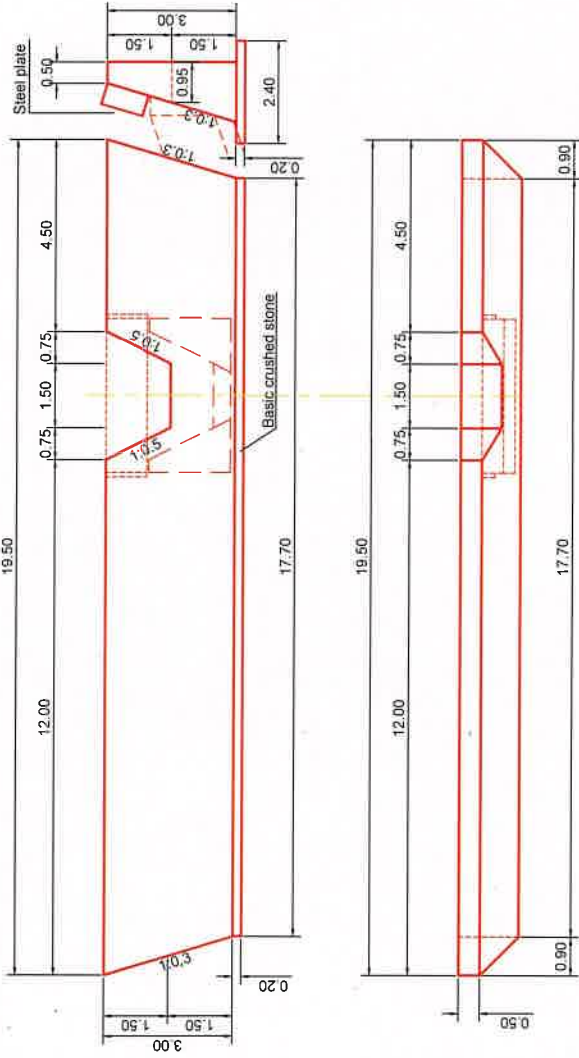

Steel plate

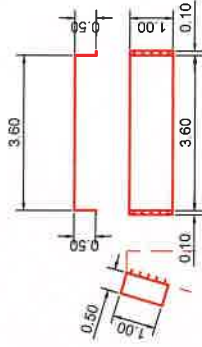

Retaining wall No.4

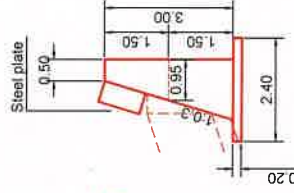
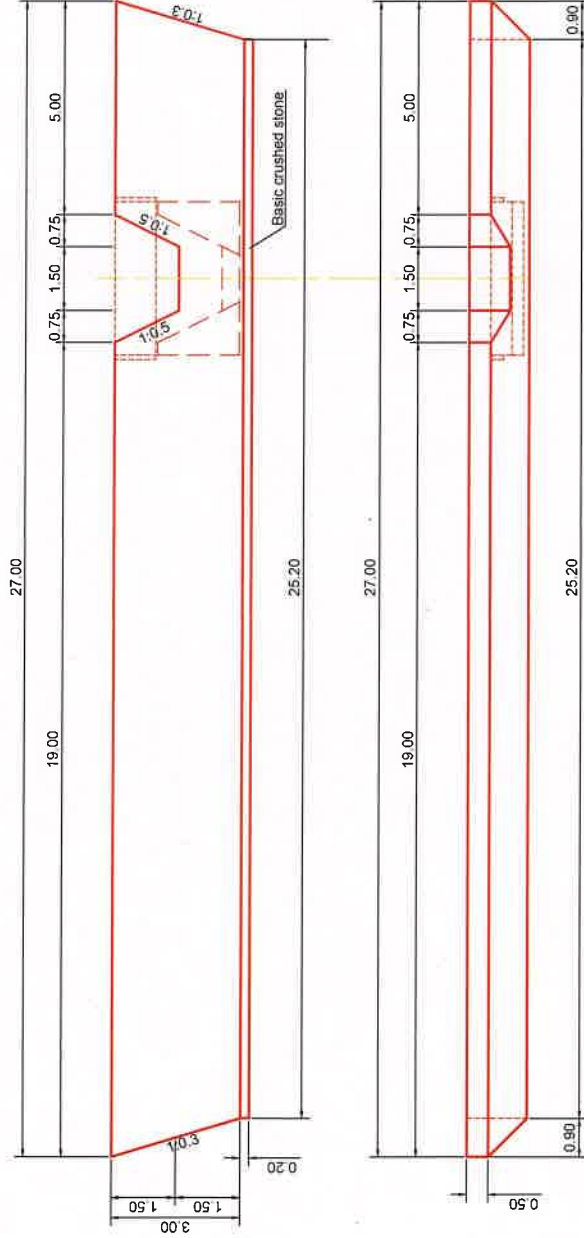

[Signature]

Chief Engineer
 Technical Cooperation Project
 Uttarakhand Forest Resource Management Project
 NTFP Centre, 49, IT Park
 Dehradun-248001

CLIENT:-	TECHNICAL COOPERATION PROJECT, UTTARAKHAND FOREST RESOURCE MANAGEMENT PROJECT, DEHRADUN		
TITLE:-	RETAINING WALL NO. 3 & 4		
PREPARED BY.	DB	20.06.2022	113
CHECKED BY.	AR	25.06.2022	113
APPROVED BY.	JKS	28.06.2022	<i>[Signature]</i>
DR. NO:-	ML/RW/2021/19	REV.	0
LOCATION:-	MALLA	SCALE:-	NTS.



Retaining wall No.1

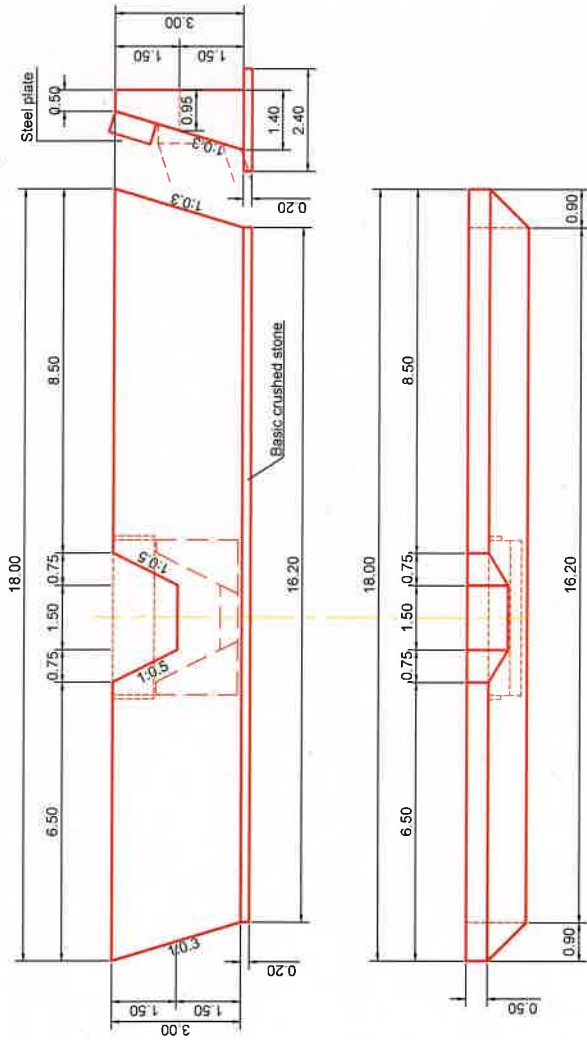

Retaining wall No.2

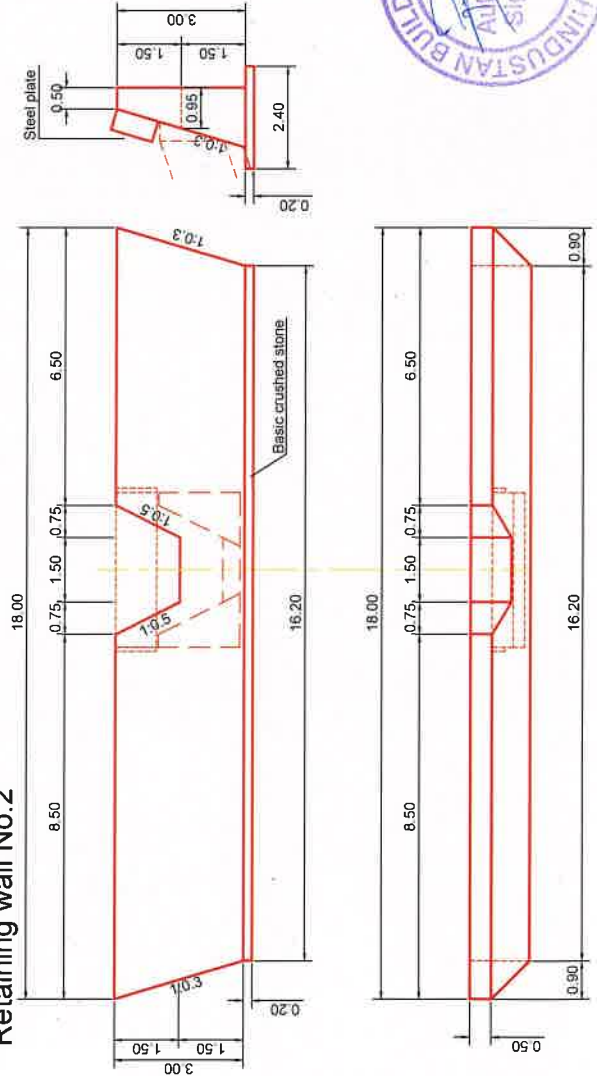

Steel plate

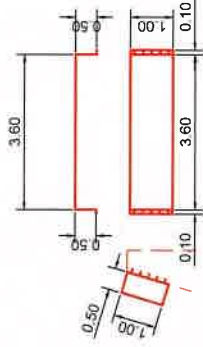

J. Sharma
 Chief Engineer
 Technical Cooperation Project
 Uttarakhand Forest Resource Management Project
 NTFP Centre, 49, IT Park
 Dehradun-248001



CLIENT:-	TECHNICAL COOPERATION PROJECT, UTTARAKHAND FOREST RESOURCE MANAGEMENT PROJECT, DEHRADUN		
TITLE:-	RETAINING WALL NO. 1 & 2		
PREPARED BY:	DB	20.06.2022	114
CHECKED BY:	AR	25.06.2022	<i>J. Sharma</i>
APPROVED BY:	JKS	28.06.2022	<i>J. Sharma</i>
DR. NO:-	ML/RW/2021/20	REV.	0
LOCATION:-	MALLA	SCALE:-	NTS.

Band work No.5

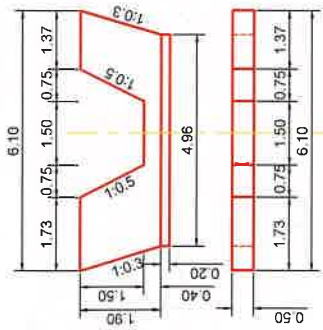

Band work No.8

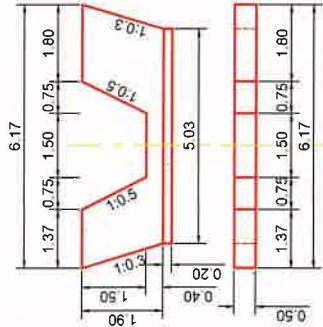

Band work No.12,13,14,15

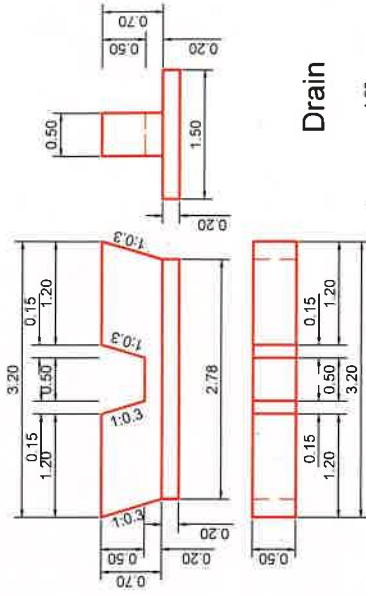

Band work No.3

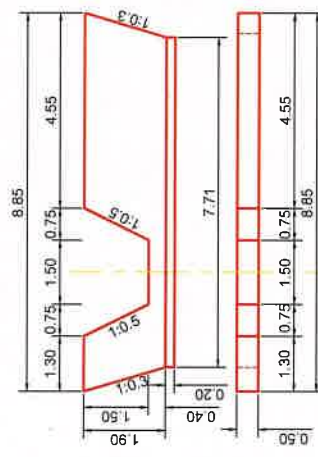

Band work No.7

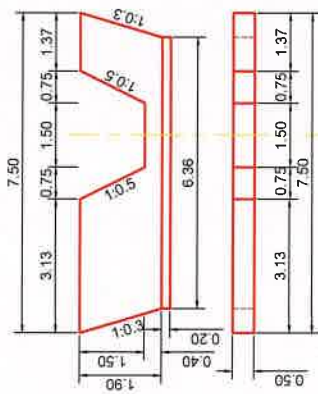

Band work No.9

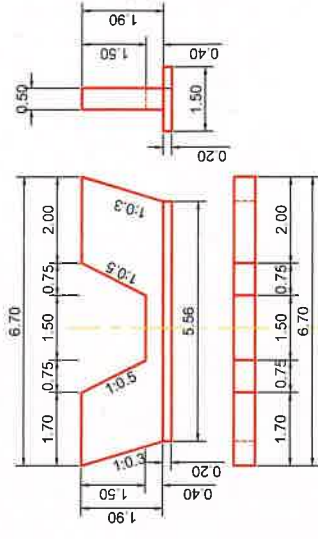

Band work No.1,2,4,10,11

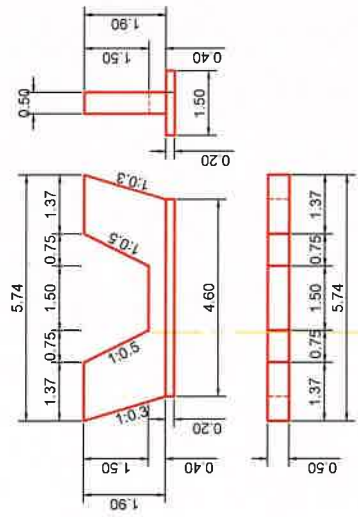

Band work No.6

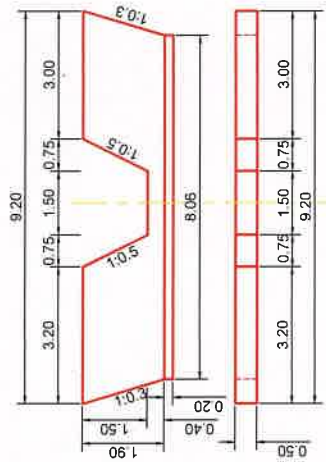

Drain

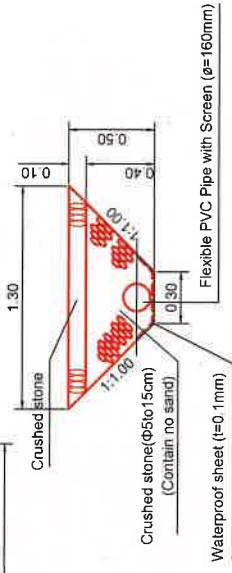

[Signature]

Chief Engineer
 Technical Cooperation Project
 Uttarakhand Forest Resource Management Project
 NTP Centre, 49, IT Park
 Dehradun-248001

CLIENT:-	TECHNICAL COOPERATION PROJECT, UTTARAKHAND FOREST RESOURCE MANAGEMENT PROJECT, DEHRADUN		
TITLE:-	DETAILS OF BAND WORK & DRAIN		
PREPARED BY.	DB	20.06.2022	115
CHECKED BY.	AR	25.06.2022	
APPROVED BY.	JKS	28.06.2022	
DR. NO:-	ML/BWD/2021/21	REV.	0
LOCATION:-	MALLA	SCALE:-	NTS.

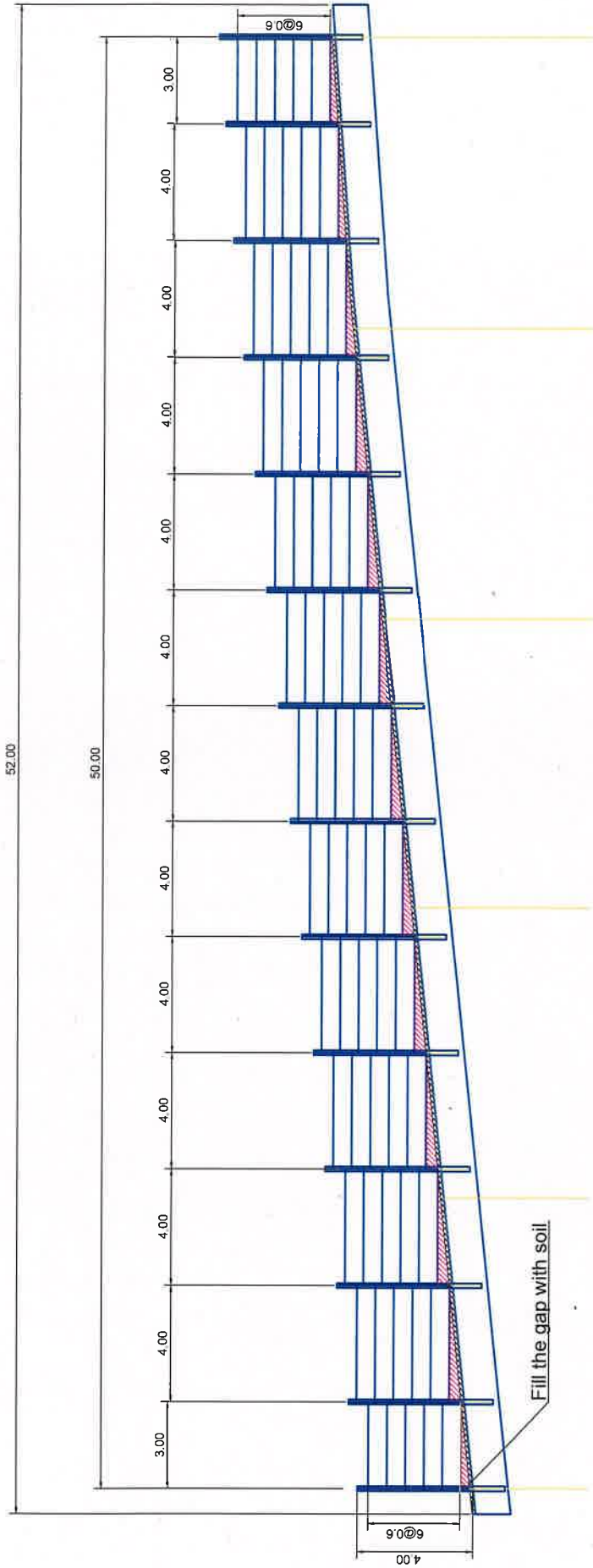

305-165-40 or equivalent
 Tensile Strength 410N/mm²
 Yield Stress 250 n/mm²~

U-section Steel sheet pile PU12 or equivalent
 Tensile Strength 480N/mm²~
 Yield Stress 355 n/mm²~

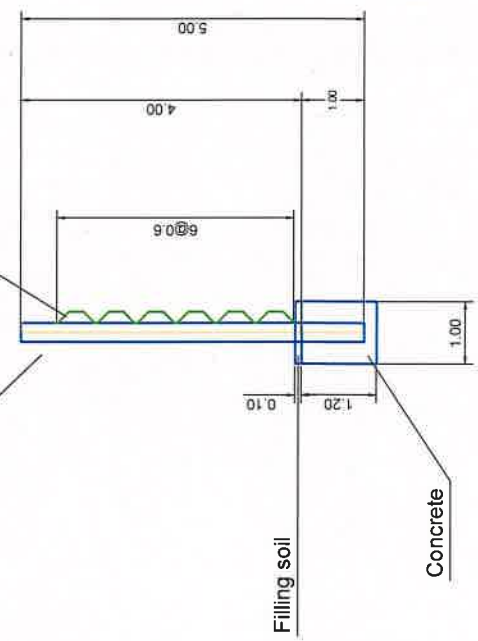

J.S. Sharma
 Chief Engineer
 Technical Cooperation Project
 Uttarakhand Forest Resource Management Project
 NTFP Centre, 49, IT Park
 Dehradun-248001

CLIENT:-	TECHNICAL COOPERATION PROJECT, UTTARAKHAND FOREST RESOURCE MANAGEMENT PROJECT, DEHRADUN		
TITLE:-	ROCK FALL PROTECTION FENCE 116		
PREPARED BY.	DB	20.06.2022	<i>J.S. Sharma</i>
CHECKED BY.	AR	25.06.2022	<i>J.S. Sharma</i>
APPROVED BY.	JKS	28.06.2022	<i>J.S. Sharma</i>
DR. NO:-	ML/RPF/2021/22	REV.	0
LOCATION:-	MALLA	SCALE:-	NTS.

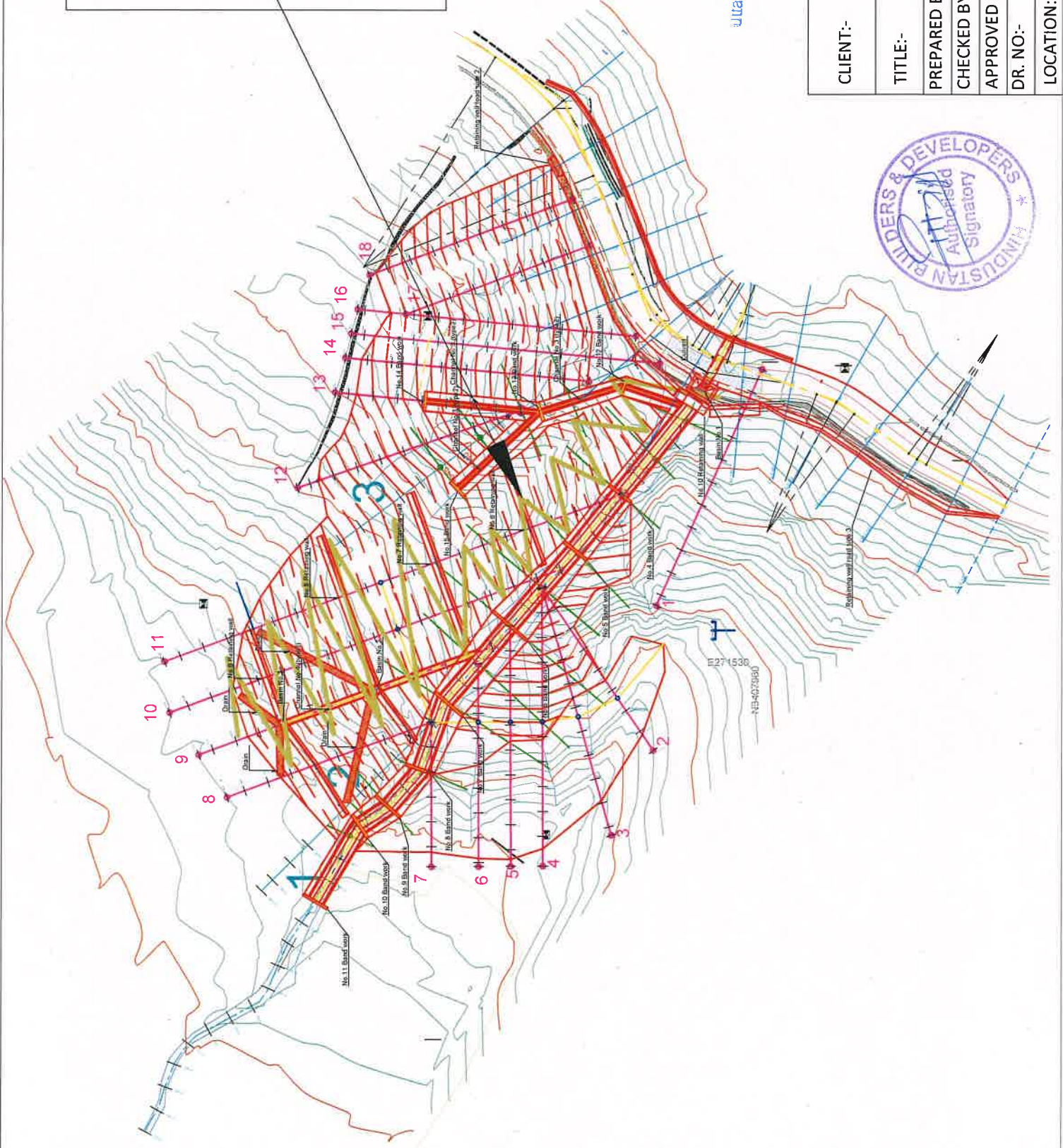
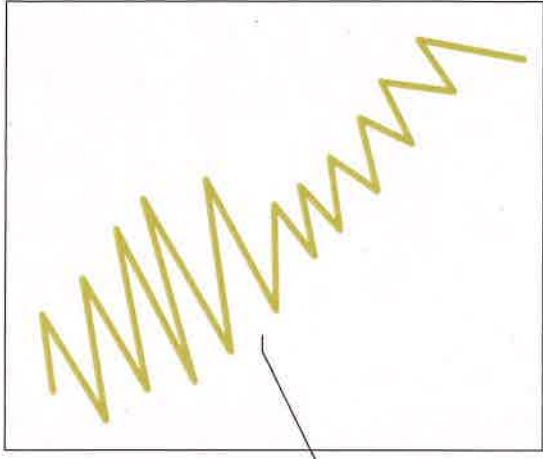

[Signature]

Chief Engineer
Technical Cooperation Project
Uttarakhand Forest Resource Management Project
NTFP Centre, 49, IT Park
Dehradun-248001

CLIENT:-	TECHNICAL COOPERATION PROJECT, UTTARAKHAND FOREST RESOURCE MANAGEMENT PROJECT, DEHRAQUN		
TITLE:-	SKETCH OF TEMPORARY ACCESS ROAD		
PREPARED BY.	DB	20.06.2022	11
CHECKED BY.	AR	25.06.2022	17
APPROVED BY.	JKS	28.06.2022	<i>[Signature]</i>
DR. NO.:-	ML/TR/2021/23	REV.	0
LOCATION:-	MALLA	SCALE:-	NTS.

Safety Manual for Slope Work

FOR THE PROJECT FOR NATURAL DISASTER
MANAGEMENT IN FOREST AREAS IN
UTTARAKHAND



J. Sharma
Chief Engineer
Technical Cooperation Project
Uttarakhand Forest Resource Management Project
NTFP Centre, 49, IT Park
Dehradun-248001

Contents

1	Safety tools.....	1-1
1.1	Outline of lifeline use for slope works.....	1-1
1.2	Type of safety tools.....	1-1
1.2.1	Safety belt.....	1-1
1.2.2	Lanyard.....	1-2
1.2.3	Lifeline/ safety line.....	1-2
1.3	Requirement for tools.....	1-2
1.3.1	Safety belt.....	1-2
1.3.2	Lanyard.....	1-2
1.3.3	Lifeline (rope).....	1-2
1.4	Method of tool use.....	1-3
1.4.1	Fixing lifeline with grip.....	1-3
1.4.2	Fixing lifeline at slope shoulder and protection of lifeline.....	1-3
1.4.3	Cautions and restrictions.....	1-3
1.5	Maintenance of tools.....	1-4
2	Working method.....	2-1
2.1	Preparation.....	2-1
2.2	Working.....	2-1
2.3	Other cautions and restrictions.....	2-2
2.3.1	Use of equipment.....	2-2
2.4	Safety check sheet.....	2-2
3	Safety codes.....	3-1
3.1	General safety.....	3-1
3.2	Machinery/ operations.....	3-1
3.3	Transportation.....	3-1
3.4	Civil engineering construction.....	3-2





Chief Engineer
 Technical Cooperation Project
 Uttarakhand Forest Resource Management Project
 NTFP Centre, 49, IT Park
 Dehradun-248001

1 Safety tools

1.1 Outline of lifeline use for slope works

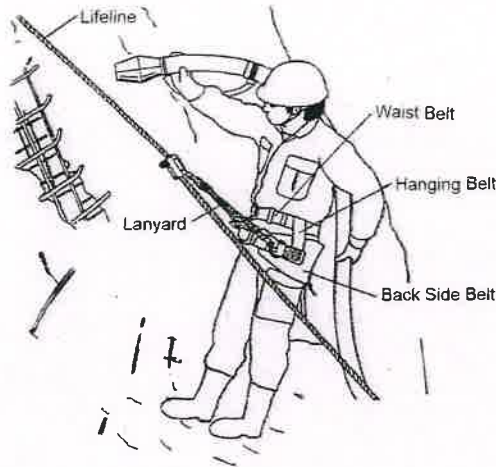
Figure 1 shows the example of lifeline use on slope. Lifeline is used with lanyard and safety belt.



Source: Japan Slope Protection Association

Figure 1: Outline of lifeline use

1.2 Type of safety tools

1.2.1 Safety belt

Safety belt for slope work consists of waist belt, backside belt, D-ring, and buckles.

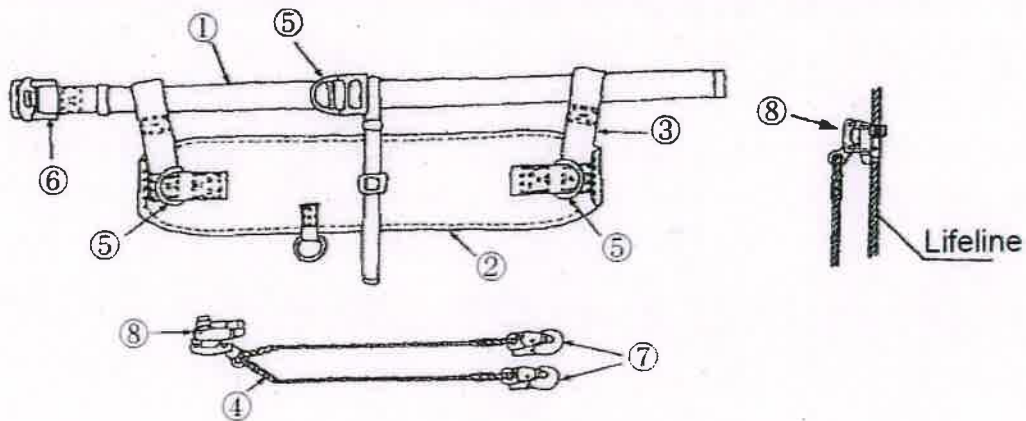

- ①Waist belt ②Backside belt ③Hanging belt ④Lanyard ⑤D-ring ⑥Buckle ⑦Hook
- ⑧Grip

Source: Japan Construction Occupational Safety and Health Association

Figure 2: Safety belt for slope work



M. Sharma
Chief Engineer
 Technical Cooperation Project
 Uttarakhand Forest Resource Management Project
 NTFP Centre, 49, IT Park
 Dehradun-248001

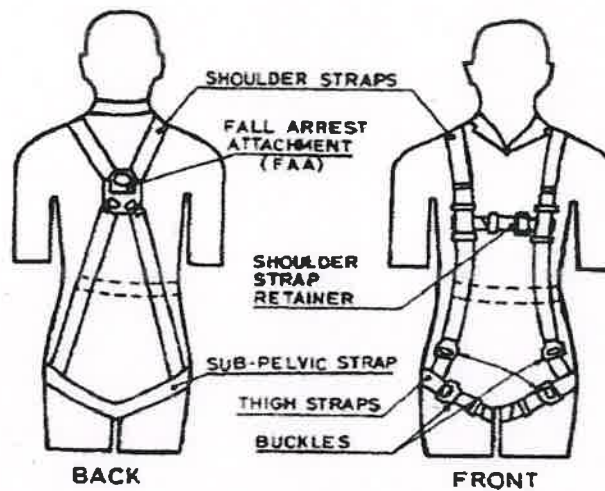

Figure 3: Multipurpose full-body safety belt for slope work

1.2.2 Lanyard

Lanyard consists of grip, lanyards and hooks.

1.2.3 Lifeline/ safety line

Only nylon, polyester or synthetic fiber shall be used.

1.3 Requirement for tools

1.3.1 Safety belt

The minimum width and thickness of webbing for waist straps shall be 40 mm and 3 mm, respectively. Waist belts, shoulder straps, hoisting straps, sole straps and all types of belts and harnesses shall not break under a minimum tensile load of 19.6 kN (approximately 2,000 kg).

Above items shall be purchased as a complete safety belt set, and shall not be purchased in parts.

1.3.2 Lanyard

The length of lanyard shall not be more than 3m in length, subject to the condition that free fall shall not be more than 1.8m.

Above items shall be purchased as a complete lanyard set, and shall not be purchased in parts.

1.3.3 Lifeline (rope)

Lifeline shall not be broken by tensile load of 19.6 kN (approximately 2,000 kg) when tested in accordance with test method reference.



1.4 Method of tool use

1.4.1 Fixing lifeline with grip

Cylindrical in shape, a grip is used to pass a lifeline through its hole, and is divided into two parts.

Procedure to set:

1. Loosen the screw to open the grip.
2. Set lifeline into one half of the grip
3. Set another half of the grip and tighten the screw

1.4.2 Fixing lifeline at slope shoulder and protection of lifeline

- Synthetic rope with a diameter of 18 mm shall be used for lifeline.
- The upper end of lifeline shall be fixed at a minimum of two points.

In case of tree: The minimum diameter shall be 20 cm, it shall be stable, with well-developed roots.

In case of anchor bar: The minimum diameter shall be 19 mm and put into the ground for a minimum of 70 cm by hammer.

- In case the lifeline touches the shoulder of slope, material to avoid friction shall be set, for instance, round pipes. The position where friction may occur shall be protected by cover etc.
- Removed lifeline from tree or anchor bar shall be kept in the designated place after lowering or winding up.
- Tying method shall be considered so as to tighten when load is applied, and loosen in case of no load.

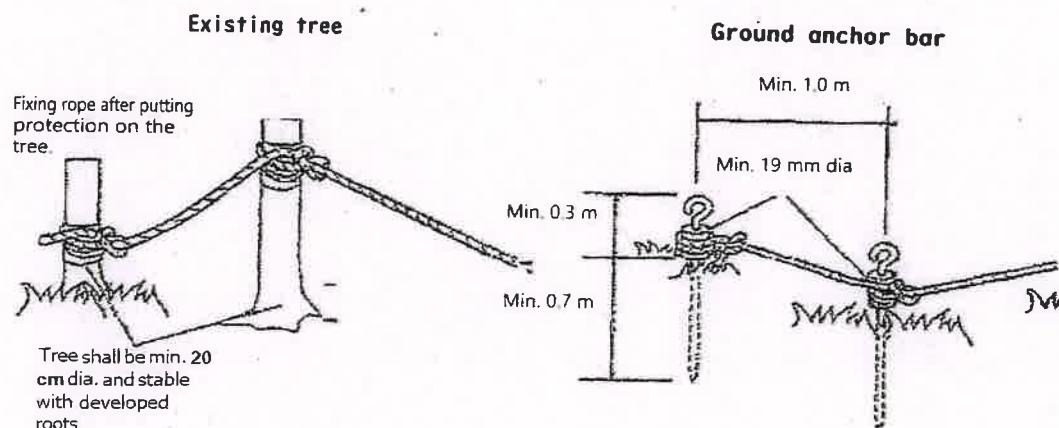

Source: Japan Slope Protection Association

Figure 4: Method for fixing and tightening of lifeline

J. Sharma
 Chief Engineer
 Technical Cooperation Project
 Uttarakhand Forest Resource Management Project
 NTFP Centre, 49, IT Park
 Dehradun-248001

1.4.3 Cautions and restrictions

- Safety belt and lifeline shall be connected to a safe area (flat area). (Attachment and removal



of safety belt shall be done at a safe place without fear of crashes and fall, such as a flat place of slope end, or the inner side of a handrail.)

- Connection, disconnection or loosening between safety belt and lifeline shall not be conducted on the slope.
- Safety belt shall be used not only for slope works but also for working on shoulder and catwalk.
- Lifeline shall be fixed to least two points of anchor bars or trees. The condition of tying, existence of sag, etc. shall be checked before use. The position where a lifeline may be abraded shall be protected by cover.
- Lifeline shall have enough length to reach to the end of slope or catwalk without any joint.
- Fall down protection fence with stable handrail shall be installed at shoulder, cliff and catwalk of slope.
- Tools and protection gear that conform to safety standards shall be used. Special care shall be taken about specifications of safety gear such as safety belts so that they are standardized and adhere to the regulations laid out by the law of India. Personally-made or modified tools and gears shall not be used.
- Temporary safety stairs shall be prepared for going up and down on the slope.
- Tools and safety protection gears shall be checked before starting work every day. Results and countermeasures shall be recorded.
- Spare tools and safety gears shall be stocked on site. When defective products are found during checking, they shall be immediately replaced with new ones.

1.5 Maintenance of tools

- When storing, safety belts shall be stocked in a designated shaded and dry space, and shall not be put directly on the ground.
- Material of belts and ropes shall be synthetic fiber. Do not drag them on the ground.
- In case mud, concrete, oil, etc., stick to belt, rope, etc., they shall be wiped down by dry cloth before stocking.
- Dirt on metal shall be wiped down and oiled regularly.
- Check before start work: Checking of lifelines and safety belts shall be conducted by the person who is nominated by the team leader. Check sheet shall be used for checking. Defects found during checking shall be repaired, or replaced with new ones.
- Check during work: If any abnormality is found on lifelines and safety belts, immediately stop their usage, take them to a safe place and inspect them for problems. If defects are found, replace them with new ones.



Chief Engineer
Technical Cooperation Project
Uttarakhand Forest Resource Management Project
NTFP Centre, 49, IT Park
Dehradun-248001

2 Working method

2.1 Preparation

In case it is difficult to install scaffolding on the slope, a lifeline shall be fixed and tightened at a minimum of two points on stable trees or with anchors. A lifeline shall be extended up to the end of slope or catwalk without any joint. Fall-down protection fence with stable handrail shall be installed at shoulder, cliff and catwalk of slope.

2.2 Working

Methods of safety measures for slope works are shown in Figure 4. Type A is the method that uses two ropes. Type B uses a rope and a safety block. The procedure of working is:

1. Install fall-down protection fence on the shoulder and catwalk;
2. Set anchor pins;
3. Tighten the rope to the trees or anchor pins;
4. Set safety block for Type B;
5. Cover the points where ropes and wires contact with crib work;
6. Connect safety belt with lifeline by lanyard and grip;
7. Walk down the slope to the working space;
8. Start working.

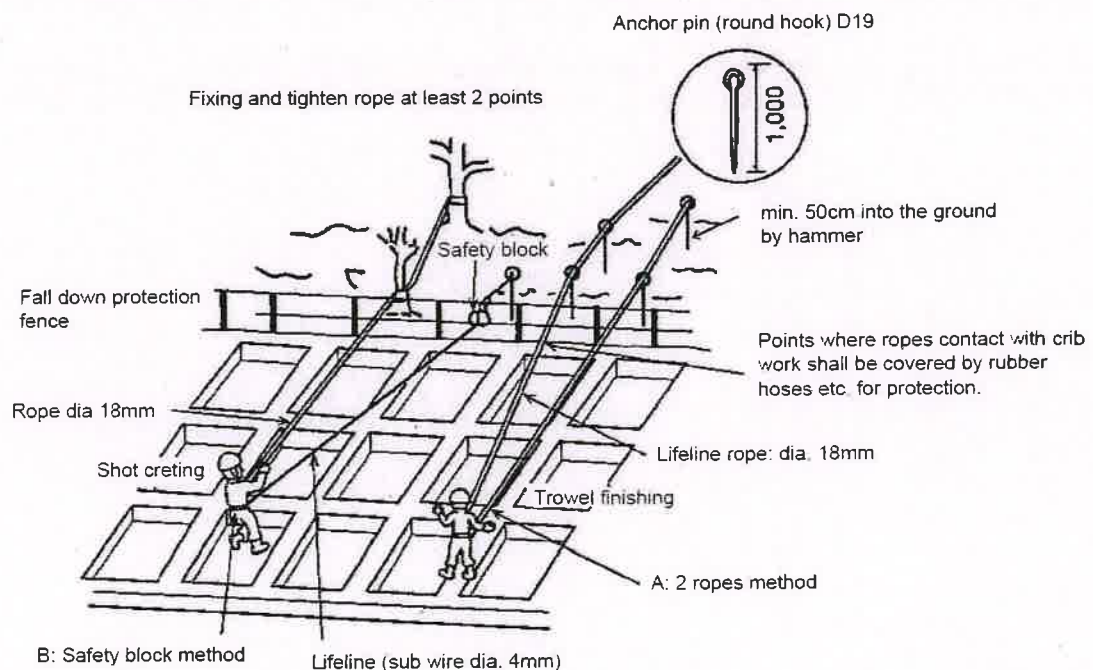

Source: Japan Construction Occupational Safety and Health Association

Figure 5: Methods for safety measures for slope works and Forest Resource Management Project

[Signature]
 Chief Engineer
 Technical Cooperation Project
 NTFP Centre, 49, IT Park
 Dehradun-248001



2.3 Other cautions and restriction

2.3.1 Use of equipment

Equipment with fall-down protective structure shall be selected. Operators shall use a seat belt in the operation cabin. Set a restricted zone in hazardous areas. Arrange guide and watchman around hazardous areas.



Source: Japan Construction Occupational Safety and Health Association

Figure 6: Protective structure for operation cabin of power shovel

When workers operate equipment where slopes and cliffs exist, they shall be aware of the high risk of accidents, avoid quick operation of equipment and look out for collapse of slope shoulders, etc.

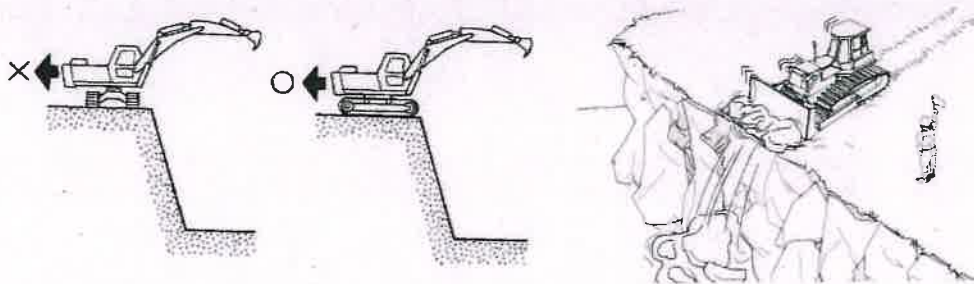

Direction of caterpillar at slope shoulder

Watch man shall be arranged at cliff.

Source: Japan Construction Occupational Safety and Health Association

Figure 7: Cautions for earth work equipment

2.4 Safety check sheet

The supervisor of the work group working on slope shall check and record safety check sheet shown in Table 1 before starting work every day.



J. Shasma
Chief Engineer
 Technical Cooperation Project
 Uttarakhand Forest Resource Management Project
 NTFP Centre, 49, IT Park
 Dehradun-248001

Table 1: Safety check sheet for slope work

☆ Restricted area		
• Is it cordoned by ropes, etc. and indicated by signboards etc.?	Yes	No
☆ Selection of licensed worker		
• Is the leader of excavation work designated and noticed on board?	Yes	No
• Is the license to operate the equipment with the operator?	Yes	No
☆ Safety for working space		
< Working platform and pathway >		
• Are safety stairs, ladders, lifts, etc. installed?	Yes	No
• Are safety conditions on the cut slope, filling slope, slope shoulder, access road, etc. confirmed?	Yes	No
< Platform >		
• Is platform with handrail for working on cliff or slope installed?	Yes	No
• Has the fall-down protection fence been installed on the shoulder and catwalk?	Yes	No
< Lifeline, safety belt >		
• Are lifelines, safety belts and lanyards inspected according to the check list by a qualified person and replaced with good ones if there are defects?	Yes	No
• Is the lifeline installed properly in accordance with the construction plan?	Yes	No
• Is a sub-lifeline by safety block etc. installed?	Yes	No
• Is the safety block functioning properly without defects on the wire, etc.?	Yes	No
• Is the lifeline fixed with strong trees or well-hammered anchor pins in at least two points?	Yes	No
• Is the position where lifeline is worn out protected by a cover?	Yes	No
• Is the rope of lifeline extended up to the end of slope or catwalk with fall protection fence?	Yes	No
• Is a set of lifeline used for more than one person?	Yes	No
• Is the slope-type safety belt used?	Yes	No
• Are workers instructed to always maintain the connection between safety belt and lifeline on the slope?	Yes	No
• Has the strength of the support of safety belt been confirmed?	Yes	No
☆ Safety instructions		
• Has the procedure of today's work been informed to the workers?	Yes	No
• Has the method to use the lifeline, safety belt, lanyard grip, etc. been explained to the workers and have they been trained adequately?	Yes	No
• Have the instructions for proper wearing of helmet, safety shoes, etc. been given?	Yes	No
• Have the workers been instructed to re-check the lifeline, safety belt and lanyard when they notice any abnormal functioning?	Yes	No
• Has the record of safety education for first-time workers on the site been confirmed?	Yes	No
☆ Weather conditions		
• Has suspension of work due to weather condition been considered?	Yes	No
☆ Instructions during meetings		
• Are health conditions of workers checked and arrangement of workers conducted adequately?	Yes	No
• Are shoes, clothes and helmets of workers checked for suitability for work?	Yes	No
• Have restricted areas been marked?	Yes	No
• Are unscheduled works and simultaneous up-and-down works prohibited?	Yes	No
• Are instructions based on the result of safety program meeting?	Yes	No
• Is the equipment used in accordance with the construction plan?	Yes	No
• Is the equipment being used checked and repaired?	Yes	No
• Is the operator instructed about working area, route, method, etc.?	Yes	No
• Are expected hazardous conditions discussed before starting work?	Yes	No
• Are there any new problems or cautions that are required for work?	Yes	No
• Other necessary issues ()	Yes	No

Source: Japan Construction Occupational Safety and Health Association



3 Safety codes

Safety codes shall conform to the following Indian Standards.

3.1 General safety

Code	Description
IS 5182: Part 1 to 21	Methods for measurement of air pollution
IS 8095: 1976	Specification for accident prevention tags
IS 8990: 1978	Code of practice for maintenance and care of industrial safety clothing.
IS 9457: 1980	Safety colors and safety signs
IS 14489: 1998	Code of practice on occupational safety and health audit.
SP 53: 1992	Hand-operated hand tools – Safety code for use, care and protection
IS/ISO/IEC: GUIDE51	Guidelines for the inclusion of safety aspects in Standards 1990

3.2 Machinery/ operations

Code	Description
IS 1991: 1988 Part 4	Safety requirements for use, care and protection of abrasive grinding wheels: Safety guards.
IS 6044: 2000 Part 1	Code of practice for liquefied petroleum gas storage installations – Part 1: Commercial and industrial cylinder installations
IS 7155: Part 1 to 8	Code of recommended practice for conveyor safety
IS 7194: 1994	Assessment of noise exposure during work for hearing conservation purpose
IS 8216: 1976	Guide for inspection of lift-wire ropes
IS 8235: 1976	Guide for safety procedures in hand-operated hand tools
IS 8324: 1988	Code of practice for safe use and maintenance on non-calibrated round steel link lifting chains and chin slings
IS 11016: 1984	General safety requirements for machine tools and their operation.
IS 11461: 1985	Code of practice for compressor safety
IS 12735: 1994	Wire rope slings – safety criteria and inspection procedures for use
IS 13367: 1992 Part 1	Safe use of cranes – code of practice – general
IS 13583: 1993 Part 1	Cranes – training of drivers: general
IS 14817: 2004 Part 2	Mechanical vibration – evaluation of machine vibration by measurements on non-rotating parts – large land-based steam turbine generator sets in excess of 50 MW

3.3 Transportation

Code	Description
IS 4357: 1974	Methods for stability testing of forklift trucks
IS 6305: 1980 Part 1 & 2	Safety code for powered industrial trucks
Part 1 to 8	Safety
IS 12009: 1995	Automotive vehicle – safety requirements for side door of passenger cars – recommendations
IS 12056: 1987	Recommendations for safety requirements for fuel tank assembly of automotive vehicles.



IS 13944: 1994	Automotive vehicles – window retention and release systems for buses - safety requirements
IS 13971: 1994 Part 1	Rough terrain fork lift trucks – code of practice for safety – application, operation and maintenance
IS 13971: 1994 Part 2	Rough terrain fork lift trucks – code of practice for safety – general requirements
IS 14283: 1995	Automotive vehicles – accelerator control systems - safety requirements
IS 15139: 2002	Automotive vehicles – safety belt anchorages – specification
IS 15140: 2003	Automotive vehicles – safety belt assembly – specification

3.4 Civil engineering construction

Code	Description
IS 875: 1987 Part 1	Code of practice for design loads (other than earthquake) for buildings and structures dead loads – unit weights of building material and stored materials (incorporating IS 1911: 1967)
IS 1905: 1987	Code of practice for structural use of unreinforced masonry
IS 2750: 1964	Specification for steel scaffoldings
IS 3696: 1991 Part 2	Scaffolds and ladders – code of safety – ladders
IS 3764: 1992	Code of safety for excavation work
IS 4014: 1967 Part 2	Code of practice for steel tubular scaffolding – safety regulations for scaffolding
IS 4081: 1986	Safety code for blasting and related drilling operations
IS 4082: 1996	Recommendations on stacking and storage of construction materials and components at site
IS 4130: 1991	Safety code for demolition of buildings
IS 5121: 1969	Safety code for piling and other deep foundations
IS 5916: 1970	Safety code for construction involving use of hot bituminous materials
IS 7205: 1974	Safety code for erection of structural steel work
IS 7293: 1974	Safety code for working with construction machinery
IS 7969: 1975	Safety code for handling and storage of building materials.
IS 8989: 1978	Safety code for erection of concrete framed structures
IS 9706: 1997	Aerial ropeways for transport of material – code of practice for design and construction
IS 9759: 1981	Guidelines for de-watering during construction.
IS 9944: 1992	Natural and manmade fiber rope slings – recommendations on safe working loads
IS 10291: 1982	Safety code for dress divers in civil engineering works
IS 10386: 1992 Part 4	Construction, operation and maintenance of river valley projects – safety code Part 4: Handling, storage and transportation of explosives
IS 10386: 1993 Part 7	Safety code for Construction, operation and maintenance of river valley projects – fire safety aspects
IS 10386: 1983 Part 10	Safety code for construction, operation and maintenance of river valley projects – storage, handling, detection and safety measures for gases, chemicals and flammable liquids
IS 11972: 1987	Code of practice for safety precautions to be taken when entering a sewerage system
IS 13063: 1991	Code of practice for structural safety of buildings on shallow foundations on rocks
IS 13415: 1992	Protective barriers in and around buildings – code of safety
IS 13416: 1992 Part 1	Recommendations for preventive measures against hazards at work places – falling material hazards prevention



IS 13430: 1992	Code of practice for safety during additional construction and alteration to existing buildings
IS 14734: 1999	Balancing machines – enclosures and other safety measures
SP 70: 2001	Handbook on construction safety practices

Note: The contractor shall not be absolved of all other safety codes applicable with respect to construction, use of construction machinery, and safety against fire and personal damage/accidents.



Chief Engineer
Technical Cooperation Project
Uttarakhand Forest Resource Management Project
NTFP Centre, 49, IT Park
Dehradun-248001

Supervision Plan

Contents

1	Summary of the Contract	1
2	Plan of Supervision.....	3
2.1	Organization	4
2.2	Language	4
2.3	Standards	4
2.4	Standard document on supervision	5
2.5	Flow of supervision work.....	5
2.6	Details of supervision work.....	5
2.6.1	Approval of construction plan.....	5
2.6.2	Approval of material	11
2.6.3	Approval of shop drawing.....	11
2.6.4	Survey and setting out.....	13
2.6.5	Inspection on site	13
2.6.6	Quality control	13
2.6.7	Measurement.....	14
2.6.8	Supervision of work schedule	14
2.6.9	Supervision of safety control	15
2.6.10	Supervision of protection of environment.....	17
2.6.11	Progress meeting (monthly, weekly, etc.).....	20
2.6.12	Monthly progress report.....	21
2.6.13	Instructions and warning	23
2.6.14	Management of supervision documents.....	23
2.6.15	As-built documents	24
2.6.16	Final Inspection.....	24
2.6.17	Completion certificate.....	24
2.6.18	Release of performance security	25
3	Quality control sheet (QCS)	25
4	Safety control sheet (SCS)	25



Chief Engineer
 Technical Cooperation Project
 Uttarakhand Forest Resource Management Project
 NTFP Centre, 49, IT Park
 Dehradun-248001

Abbreviations

BIS	British Indian Standard
BOQ	Bill of Quantity
CAD	Computer Aided Design
CDRW	Compact Disk Re Writable
CPCB	Central Pollution Control Board
CPM	Critical Path Method
CTC	Center to Center
GCC	General Condition of Contract
IRC	Indian Road Congress
IS	Indian Standard
IT	Information Technology
PHSP	Project Health and Safety Plan
PWD	Public Works Department
QA	Quality Assurance
QC	Quality Control
QCS	Quality Control Sheet
SCS	Safety Control Sheet
TCP	Technical Cooperation Project
UFRMP	Uttarakhand Forestry Resource Management Project
UKFD	Uttarakhand Forestry Department



J. Sharma
 Chief Engineer
 Technical Cooperation Project
 Uttarakhand Forest Resource Management Project
 NTFP Centre, 49, IT Park
 Dehradun-248001

1 Summary of the Contract

- Contract No. : 03/2022-23,
- Name of work : Stabilization of Slopes at Malla near Bhatwari in Uttarkashi District.
- Under the project : Project for Natural Disaster Management in Forest Areas in Uttarakhand project:
- Under the jurisdiction of : Chief Project Director, Uttarakhand Forest Resource Management Project, 49, IT Park, Sahasradhara Road, Dehradun
- Site Location : Malla near Bhatwari in Uttarkashi District
- Description of work : **Stabilization of land-slid Hillslope in Malla near Uttarkashi -** Construction of hill side works, retaining walls on slope, Installation of erosion control mats, channeling of stream water, collection pits NH road construction and drainage channel upto suitable stream as per BOQ.



Chief Engineer
Technical Cooperation Project
Uttarakhand Forest Resource Management Project
NTFP Centre, 49, IT Park
Dehradun-248001

2 Plan of Supervision

2.1 Organization

Supervision organization shall be as committed by the contractor in their proposal under Form Tech 3 under Key Personnel proposed and ToE

2.2 Language

Language shall be in English as specified in the contract document.

2.3 Standards

Special attention of the Firm is drawn to the relevant sections and clauses of the National Building Code of India, 1984, PWD specifications and latest BIS Codes (latest editions along with amendments) and should follow them strictly, in addition to the specifications and conditions stipulated in this volume.

Materials and workmanship shall comply with the relevant Indian Standards (with amendments), unless a more recent amendment is specified hereinafter, or with the requirements of any other authoritative standard approved by UFRMP, which shall be no less exacting in the opinion of UFRMP than the corresponding standard quoted herein.

The following Indian Standards which are IMPORTANT and are referred to in general specifications and used in construction works. These standards are to be strictly adhered to unless otherwise is applicable in the relevant context. These standards are to be followed both in respect of materials and construction of civil engineering works included in the bids.

Table 1: List of IS Specifications

No.	IS No.	Description
1	269-1976	Ordinary and low heat Portland cement
2	383-1970	Coarse and fine aggregates from natural sources for concrete
3	455-1976	Portland slag cement
4	456	Code of practice for plain and reinforced cement concrete
5	516-1959	Methods of test for the strength of concrete
6	800-1984	Code of practice for general construction in steel
7	1199-1959	Method of sampling and analysis of concrete
8	3385	Code of practice of measurement of civil engineering works
9	2116-1980	Sand for masonry mortars
10	2250-1981	Code of practice for preparation and use of masonry mortars
11	2386 (pt.1-8)	Methods of testing for aggregate for concrete
12	2720	Methods of test for soil
13	3370 (pt-1-4)	Code of practice for concrete structures for storage of water
14	3764-1966	Code of practice for excavation work
15	4082-1977	Recommendations on stacking and storage of construction material at site
16	7293-1974	Safety code for working with construction machinery
17	7969-1975	Safety code for handling and storage of building material
18	7293	Safety code for working with construction machinery
19	IRC Code	Indian Road Congress (IRC) code for road construction



[Signature]
Chief Engineer
 Technical Cooperation Project
 Uttarakhand Forest Resource Management Project
 NTFP Centre, 49, IT Park

2.4 Standard document on supervision

1. Contract
2. General condition of contract (GCC)
3. Technical proposal including:
 - Technical specifications
 - Construction drawings
 - Technical forms
4. Price schedule (BOQ) and commercial conditions
5. Supervision plan
6. Quality assurance (QA) / quality control (QC) plan
7. Safety plan

2.5 Flow of supervision

Figure 2 shows the flow of supervision.

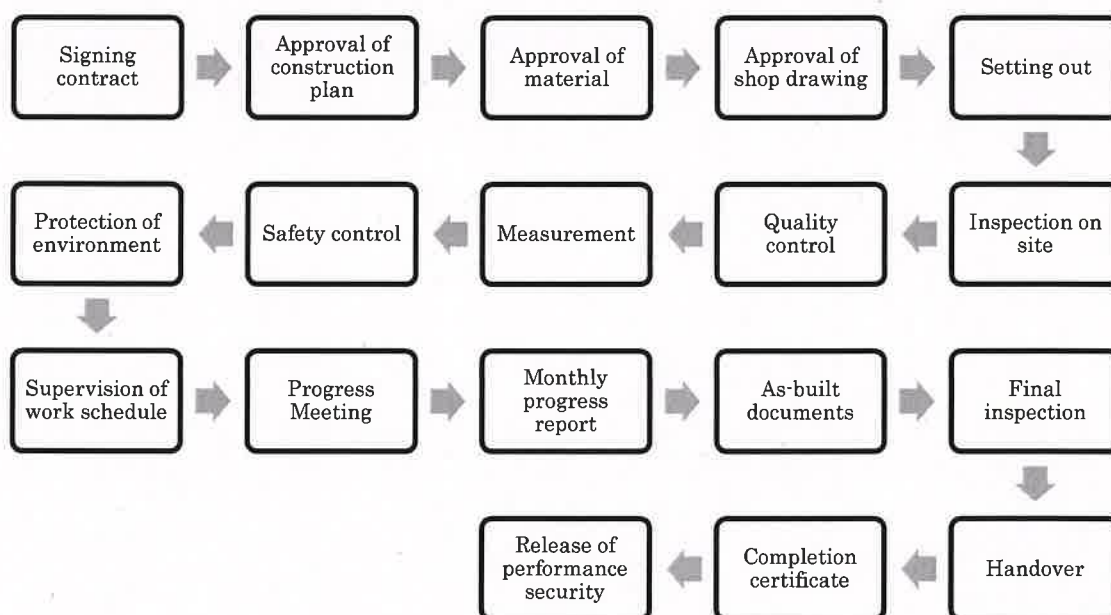

Figure 1: Flow of supervision

2.6 Details of supervision work

2.6.1 Approval of construction plan

Unless otherwise specified, at least 28 (twenty-eight) days before the commencement of the works, the Contractor shall submit the following construction plans for the Engineer's approval.



[Signature]
Chief Engineer
 Technical Cooperation Project
 Uttarakhand Forest Resource Management Project
 NTFP Centre, 49, IT Park
 Dehradun-248001

The Engineer shall examine the construction plan based on contract documents such as technical specification, drawings, etc. If there is not enough description or any discrepancy between the construction plan and the contract documents, the Engineer shall request the construction plan to be revised. The Engineer shall issue a letter of approval of the construction plan upon approval.

1. Work schedule
2. Construction method
3. Temporary work plan
4. Quality control method
5. Measurement method
6. Safety precautions
7. Plan for disposal of surplus soil
8. Plan for waste disposal
9. Environmental protection measures

a. Work schedule

The Engineer shall request the contractor to submit the master and detail schedule, the format of which is shown in the Annex, for whole work at the site. The Engineer shall examine whether the proposed schedule is applicable and within the period mentioned in the contract.

b. Construction method

Based on the check points shown in Table 2, the Engineer shall examine the construction method submitted by the Contractor.

Table 2: Check points for construction method

Type of work	Check points
1. Structure of construction management	<ul style="list-style-type: none"> • Organization chart, personnel, address, telephone number, etc., for construction management by the Contractor including subcontractor • Name, personnel, address, telephone number of related organizations such as UFRMP, UKFD division office, Highway Authority, Irrigation Department, local government, police office, fire station, hospital, etc.
1. Temporary work	Access road, office, labor house, stockyard water supply, electricity supply, drainage, sewerage, temporary rockfall prevention fence, transportation method for material



Chief Engineer
 Technical Cooperation Project
 Uttarakhand Forest Resource Management Project
 NTFP Centre, 49, IT Park
 Dehradun-248001

Type of work	Check points
2. Survey and setting out	Control point, survey method, detail of profile
3. Ground sill	Source of stone material and filling
4. Check dam	Form work, Rebar work, concrete mixing and pouring
5. Soil bag channel (if to be applied)	Material of soil, control of size of soil bag, CTC of rebar, shop drawing of plan
6. Cement concrete channel	Form work, Rebar work, concrete mixing and pouring
7. Pipe culvert under national highway	Procurement of material of concrete pipe, type and capacity of truck crane to install concrete pipe, step of installation, traffic diversion
8. Cut slope	Safety measures for manpower and equipment, excavation method, means of transportation and disposal of excavated soil
9. Covering work	Procurement of erosion control mat, preparation of surface, procedure of laying and fixing
10. Hydro seeding	Safety measures for manpower and equipment, selection of hydro seeding mixtures, hydro seeding equipment type, preparation area, scaffolding
11. Retaining wall work along public road	Formwork, position and treatment of concrete joint, concrete mixing, pouring concrete, curing, removal of formwork, expansion joint, construction joint, etc.
12. Fence work	Procurement and quality control of wooden log, how to drive iron bar, scaffolding
13. Gabion Retaining wall	Procurement of stone material, setting gabion
14. Rock bolt work	Safety measures for manpower and equipment, scaffolding, drilling equipment
15. Rock Netting	Safety measures for manpower and equipment, scaffolding, drilling equipment

c. Temporary works plan

The Engineer shall examine the temporary works plan submitted by the Contractor based on the check points shown in Table 3.

The Contractor shall furnish construction yards that shall be flat, suitably graded and covered



Chief Engineer
 Technical Cooperation Project
 Uttarakhand Forest Resource Management Project
 NTFP Centre, 49, IT Park
 Dehradun-248001

with gravel to avoid any pooling of water and getting muddied. Construction yards shall be located at every site and shall be prepared and facilitated with Contractor's office with furniture, equipment, consumables, stockyard for various materials and parking space, etc. On completion of the Project, the construction yards, including all facilities, shall be demolished and the area shall be properly restored and returned to the legal owner.

Unless otherwise instructed by the Engineer, upon completion of the Works, the Contractor shall remove all temporary facilities including temporary roads, clean up and restore the land and vegetation to the satisfaction of the Engineer.

Table 3: Check points for temporary work plan

Type of work	Check points
1. Mobilization	Base camp, stockyard, site office, labor house, laboratory, temporary muck stock, water supply, electricity supply, drainage, sewerage, etc.
2. Access road to the site	Drawings of route, width, slope slant, etc.
3. Transportation of materials, equipment, disposals, etc., between stockyard and construction site	Drawings and safety calculation for monorail, cable crane, truck, tractor, vehicle, manpower, etc.
4. Temporary rockfall protection fence	Drawings and structural calculation to bear the load of falling rock.

d. Quality control method

The Contractor shall submit a quality control plan showing control items and values, and countermeasures in case the value does not satisfy the control value.

Engineer shall examine the quality control plan submitted by the Contractor based on the Quality Control Sheet (QCS) shown in the Annex.

e. Measurement method

Contractor shall submit a measurement plan for each and every item of BOQ in accordance with the description of measurement in Technical Specification.

The Engineer shall examine the measurement plan submitted by the Contractor.

f. Safety precautions

f.1 Project Health and Safety Plan

Within 28 (twenty-eight) days before the commencement of the works, the Contractor shall submit his Project Health and Safety Plan (PHSP). The Contractor shall cooperate and comply with Engineer's instructions to have the PHSP approved by the Engineer before works at the site commences.

Main contents of the Project Health and Safety Plan shall include following:



M. Sharma
Chief Engineer
 Technical Cooperation Project
 Uttarakhand Forest Resource Management Project
 NTFP Centre, 49, IT Park
 Dehradun-248001

1. Safety Organizations and Communication

- Safety control staff organizational structure, which should identify the personnel to be engaged solely for safety assurance (including the Contractor's Accident Prevention Officer, who will be responsible for all safety on the Site), their responsibilities and authorities.
- Proposed interaction and communication procedures between the Contractor's construction personnel and safety assurance staff.
- Frequency and coverage of site safety meetings, and regular site safety reports.
- Safety information and training
- Records to be prepared and maintained by the Accident Prevention Officer.

2. Measures for compliance by Subcontractors

3. Safety equipment and facilities

- Safety equipment, rescue apparatus and protective clothing that will be required for the Works. Such equipment shall include, but will not be limited to, eye protectors, bearing protectors, safety harnesses, safety equipment for working underground and in confined spaces, rescue equipment, fire extinguishers, first-aid equipment, lanyards, hard hats and, where appropriate, associated shock absorbers and chest harnesses.
- Testing, inspection, and replacement of safety equipment, scaffolds, guardrails, working platforms, hoists, ladders and other means of access, lifting, lighting, signing, and guarding equipment.
- Operation and equipment of the specified first-aid station.
- Emergency and rescue procedure and associated equipment.
- Any other equipment, gear and facilities necessary for prevention of accidents.

4. Protection of authorized and unauthorized visitors to the site (including people from the vicinity)

5. Supervision of safety systems

The means by which the Safety systems will be supervised, monitored and audited by the Accident Prevention Officer to ensure due compliance with the principles and objectives of the Project Health and Safety Plan, and procedures for updating the Project Health and Safety Plan

6. Safety of construction methods.

7. Proposals to ensure that construction methods do not compromise the Contractor's commitment to the Project Health and Safety Plan or his compliance with regulations.

8. Types of hazards and emergency measures

An appreciation of industrial health hazards, and proposals for minimization of the risks associated with such hazards.

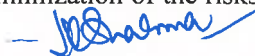

Chief Engineer
 Technical Cooperation Project
 Uttarakhand Forest Resource Management Project
 NTFP Centre, 49, IT Park
 Dehradun-248001

9. Personal Health and Sanitation Program, which focuses on measures to be adopted by the Contractor in the worker's camp to ensure that the health of every personnel hired in the Project is properly taken care of. This program includes the following:
- (i) Installation of a temporary workers' camp, which is provided with sleeping quarters, sanitary toilet and shower rooms, adequate potable water supply and lighting facilities;
 - (ii) Personal hygiene and sanitation training for workers;
 - (iii) Orientation on the prevention of communicable diseases.
 - (iv) For foreign workers, an orientation on local customs and traditions.

The design and location of the worker's camp is subject to the approval of the Engineer and local authorities.

f.2 Traffic safety plan

At least 28 (twenty-eight) days before commencement of the works, the Contractor shall submit his Traffic Safety Plan for the Engineer's approval. The Contractor shall cooperate and comply with the Engineer's instruction to have the Traffic Safety Plan approved by him before the start of site works.

The Traffic Safety Plan shall comprise of the following:

- Type and main specifications of traffic control devices and facilities;
- Details of all lane widths, etc.;
- Program for installation and erection of traffic control devices and facilities;
- Arrangement plan for traffic control facilities and services;
- Traffic control methods during non-working time;
- Traffic control methods during night time;
- Flag men with STOP/ GO boards and traffic lights shall be stationed 24 hours a day and 7 days a week at both ends of the road, to guide traffic.

g. Plan for disposal of surplus soil

The Contractor shall submit the details of their chosen location for disposal, and the same shall comply with the laws of India.

h. Plan for waste disposal

The plan for waste disposal shall comply with the laws of India.

i. Environmental protection measures

The plan for environmental protection measures shall comply with the laws of India. The plan shall be implemented during work execution, and shall be monitored on a daily basis. The Contractor shall take into account all statutes, regulations and all applicable local government by-laws while



[Signature]
Chief Engineer
 Technical Cooperation Project
 Uttarakhand Forest Resource Management Project
 NTFP Centre, 49, IT Park
 Dehradun, 248004

preparing the plan.

1. All works should be arranged to cause least possible disturbance to the environment and focal residents/institutions, in particular soil erosion, along the right of way and adjacent area, to the river/stream banks, irrigation canals and other waterways. Similarly, cutting of trees, tea shrubs and other vegetation of economic, religious and ecological value found outside of the ROW, whenever possible, shall be avoided; else, replacement planting in a place selected by the owner of the affected tree and/or vegetation will be carried out by the Contractor in lieu of the damage caused.
2. Proposals shall be submitted for:
 - (i) Vehicular traffic management;
 - (ii) Location of temporary structures,
 - (iii) Garbage disposal site;
 - (iv) Storage area of construction materials, fuel and other petroleum products;
 - (v) Demolition of unwanted structures;
 - (vi) Cleaning up of work areas upon completion of all work; and the like.

The above proposals shall have the approval of the Engineer.

3. All spoils and unsuitable material shall be disposed of in accordance with provisions of the Specification and Applicable Law.

2.6.2 Approval of material

The Engineer shall request the Contractor to submit the material sample sheet along with mill sheets, test reports, brochures, manufacturer's certificates etc. on each material as evidence to show that the material complies with technical specifications, at least 21 (twenty-one) days before the commencement of works or procurement of materials, whichever occurs earlier.

The Engineer shall examine the material based on technical specifications. After the Engineer has confirmed that the material conforms to the technical specifications, he shall issue the approval in writing to the Contractor.

The Engineer shall instruct the Contractor to not commence the work or purchase the material without the Engineer's approval. In case the contractor fails to submit appropriate documents to the Engineer's satisfaction to the Engineer and are necessary for approval by the Engineer by the aforesaid period, the Engineer's approval will be issued 21 days after receiving satisfactory documents from the contractor and the consequences of the delay incurred from such situation shall be borne by the Contractor.

2.6.3 Approval of shop drawing

Unless otherwise specified, at least 28 (twenty-eight) days before the commencement of the works, the Contractor shall draw the shop drawings based on the actual on-site condition, such as landscaping, existing public infrastructures, etc., and submit to the Engineer for approval.

The Engineer shall examine the shop drawing based on contract drawings and the actual condition on site. After the Engineer is satisfied that the shop drawing is applicable for work, he shall issue



[Signature]
Chief Engineer
 Technical Cooperation Project
 Uttarakhand Forest Resource Management Project
 NTFP Centre, 49, IT Park
 Dehradun-248001

the approval in writing to the Contractor.

In case the site condition has changed and the shop drawing is not applicable, the Engineer shall request the Contractor to revise the shop drawing.

The Engineer shall instruct the contractor not to commence the work or purchase material without the Engineer's approval of shop drawing.

In case the contractor fails to submit appropriate shop drawings that are to the satisfaction of the Engineer and necessary for approval by him by the aforesaid period, the Engineer's approval will be issued 21 days after receiving satisfactory drawings from the contractor and the consequences of the delay incurred from such situation shall be borne by the contractor.

Table 4: Example of necessary shop drawings

Type of work	Shop drawing
1. Temporal work	Layout of each site showing the control points based on the actual survey by the contractor, layout of base camp and stockyard, plan/ section for access road, plan/ section/ detail for transportation equipment at Padli, such as mono rail, cable crane, etc.
2. Ground sill	Plan, section, detail of assembling cage frame, layout and details of lifeline and scaffolding.
3. Check dam	Plan, section, details of assembling steel frame and expand metal.
4. Gabion retaining wall	Plan, section, details of retaining wall
5. Concrete retaining wall (Jawadi)	Plan, section of retaining wall, plan, section of temporary rockfall protection fence
6. Soil bag channel	Plan, section of channel work, details of fixing rebar
7. Cement concrete channel	Plan, section, rebar arrangement
8. Cut slope	Plan, section of slope, layout and details of lifeline and scaffolding
9. Crib work	Plan, section of crib work, layout and details of lifeline and scaffolding
10. Rock bolt	Plan, section, detail of rock bolt, layout and details of lifeline and scaffolding
11. Hydro seeding	Plan, section, detail of hydro seeding work, layout and details of lifeline and scaffolding
12. Fence	Plan, section, detail of fence work, layout and details of lifeline and scaffolding
13. Covering work	Plan, section, detail of erosion control mat covering work, layout and details of lifeline and scaffolding



[Signature]

Chief Engineer
Technical Cooperation Project
 Uttarakhand Forest Resource Management Project
 NTFP Centre, 49, IT Park
 Dehradun-248001

2.6.4 Survey and Setting out

The following come under job description and responsibility of the Engineer for survey and setting out:

a. Job description

- Establish basic survey points and benchmarks in cooperation with the Contractor and Site Engineer.
- Verify/ check Contractor's survey work and report.
- Verify/ check for completed works in conformity with specifications.
- Verify/ check for the measurement of completed work quantity.

b. Responsibility

- Safeguard the basic survey points and benchmarks, and establish the reference points for the loss incident.
- Verification of contractor's survey work and report
- Verification of completed work quantity.

2.6.5 Inspection on site

Engineer shall conduct the inspection upon submission of the request in writing by the Contractor. The format of the inspection sheet is shown in the Annex.

The following come under job description and responsibility of Engineer for inspection:

a. Job description

- Inspect all works, tests, machinery and materials according to technical specifications, drawing and shop drawing.
- Measure the quantity of completed works.
- Inspect as-built drawings prepared by the Contractor for the site.
- Assist Surveyor for verification of the contractor's survey and report.

b. Responsibility

- Supervise/ inspect contractor's construction work in terms of workmanship and quality in accordance with technical specifications.
- Supervise/ check the accuracy of field and laboratory tests.

2.6.6 Quality control

Engineer shall summarize the record of inspection into the quality control sheet (QCS). The format of quality control sheet is shown in the Annex.



Chief Engineer
Technical Cooperation Project
Uttarakhand Forest Resource Management Project
NTFP Centre, 49, IT Park
Dehradun-248001

2.6.7 Measurement

Generally, the measurement shall be conducted by visual/workmanship inspection and measurement of dimension in accordance with the Construction Plan approved by the Engineer.

Job description and responsibility of engineer for measurement shall be the followings.

a. Job description

- Preparation of the progress payment certificate draft, which will be based on the contractor's draft.
- Monitor and analyze the progress of construction.
- Check the BOQ and the invoice prepared by the Contractor.
- Survey and summarize monthly work quantities in cooperation with Site Engineers.
- Arrange survey work in cooperation with the Contractor.
- Prepare the quantity for the variation works.

b. Responsibility

- Progress and work measurement
- Payment certificate
- Insurance matters
- Performance security submission

2.6.8 Supervision of work schedule

1. The Contractor shall maintain on site necessary computing, printing and plotting facilities, along with suitably experienced staff to enable the program to be reviewed and updated weekly and, where necessary, revised.
2. The program shall be continually updated by the Contractor to include actual progress of the works.
3. The Engineer shall monitor day-to-day progress against scheduled progress, comparing the same with the master schedule.
4. In case the actual progress of the work is behind schedule as compared to the master schedule, the Engineer shall request the Contractor to submit a proposal for countermeasures to catch up with the master schedule.
5. The Engineer shall review the program within 7 days, and where required by the Engineer, the Contractor shall revise and resubmit the program for the consent of the Engineer.



Chief Engineer
Technical Cooperation Project
Uttarakhand Forest Resource Management Project
NTFP Centre, 49, IT Park
Dehradun-248001

2.6.9 Supervision of safety control

a. Monthly Project Health and Safety Plan

The Contractor shall submit a Monthly PHSP, the format of which is shown in the Annex, to be approved by the Engineer before the commencement of the works every month. Monthly PHSP shall comply with the approved PHSP and the Engineer's instructions on safety.

If the Engineer makes any subsequent recommendation or instructions on the PHSP in writing, the Contractor shall revise the PHSP accordingly.

Where the Contractor proposes to change, he shall give at least 7 calendar days' notice in writing. Proposed changes are subject to the Engineer's approval.

b. Accident prevention officer

1. The Contractor shall appoint an Accident Prevention Officer, whose duties throughout the period of the Contract shall be exclusively connected with safety activities on the site.
2. The Accident Prevention Officer shall be a suitably qualified and experienced person, and shall supervise and monitor compliance with the PHSP, and shall carry out auditing of the operation of the PHSP in accordance with a rolling program to be submitted, from time to time, to the Engineer for his approval.
3. The Accident Prevention Officer's selection shall be subject to the Engineer's approval.
4. The Contractor shall provide the Accident Prevention Officer with support staff, which will be in accordance with the staffing levels set out in the Project Health and Safety Plan.
5. The Contractor shall empower the Accident Prevention Officer and his staff to instruct employees of the Contractor and Subcontractors to cease operations and to take urgent and appropriate action to make the site safe and prevent unsafe working practices or other infringements of the PHSP or regulations.

c. Safety reports and notification of accidents

c.1 Safety reports

The Contractor shall submit regular site safety reports to the Engineer as a requirement of the PHSP. A summary report shall be submitted as part of the Monthly Progress Report. Prior to submission, the Contractor's Representative shall endorse the report. Site safety reports shall comprehensively address all relevant aspects of site safety and industrial health regulations and, in particular, report on all site safety audits undertaken during the period covered by the report. The format of Monthly Safety Report is shown in the Annex.

c.2 Notification of accidents

The Contractor shall notify the Engineer immediately when any accidents occur, whether on-site or off-site in which the Contractor, his personnel, Contractor's Equipment, or those of his Subcontractors are directly or indirectly involved and which result in any injuries to any persons. Such initial notification may be verbal and shall be followed by a written comprehensive report in the format approved by the Engineer within 24 hours after the accident.



J. Sharma
Chief Engineer
 Technical Cooperation Project
 Uttarakhand Forest Resource Management Project
 NTFP Centre, 49, IT Park
 Dehradun-248001

d. Safety equipment and clothing

The Contractor shall ensure that safety equipment and protective clothing as described in the PHSP are available on the site at all material times and that measures for the effective enforcement of proper utilization and necessary replacement of such equipment and clothing are incorporated into the PHSP.

1. The Contractor shall provide all authorized persons on the Site (including the Employer's and Engineer's personnel) with protective clothing, where the minimum items shall be as follows:
 - Protective headgear (hard hat or similar),
 - Safety belt
 - Reflective jacket
 - Safety boots (with steel toe caps and steel sole plate)

Other items such as safety glasses, gloves, safety harness, rubber boots etc., shall be provided as necessary to the operation being undertaken.

2. The Contractor shall provide other necessary safety equipment, clothing and facilities as instructed by the Engineer.

e. Safety inspections

The Contractor shall regularly inspect, test and maintain all safety equipment, scaffolds, guardrails, working platforms, hoists, ladders and other means of access, lifting, lighting, signing and guarding equipment. Lights and signs shall be kept clear of obstacles and shall be legible to read. Equipment, which is damaged, dirty, incorrectly positioned or not in working order, shall be repaired or replaced immediately.

f. First aid facility

The Contractor shall establish and maintain at least one first-aid facility at each site.

1. The facility shall be located at the Contractor's principal works area and shall consist of a treatment room, fitted with a hand-wash basin, a treatment bed, sterilizing equipment and lockable steel cabinet big enough to store sufficient medical supplies for the Contractor's workforce, the Engineer's site staff and any visitors to the site. In addition, two stretchers shall be available for immediate use. The facility shall contain a recovery room that shall be furnished with four chairs and a table.

g. Health and safety information and training

1. The Contractor shall ensure that safety, rescue and industrial health matters are given a high degree of publicity to all persons regularly or occasionally on the site. Posters, in Hindi and English languages, which draw attention to site safety, rescue and industrial health regulation, shall be made or obtained from appropriate sources, and shall be displayed prominently in strategic areas within the site.
2. The Contractor shall carry out regular safety training courses, the frequency, coverage and application of which shall be in accordance with the PHSP. The Contractor shall require all Subcontractors' employees to participate in relevant training courses appropriate to the nature,



Chief Engineer
 Technical Cooperation Project
 Uttarakhand Forest Resource Management Project
 NTFP Centre, 49, IT Park
 Dehradun, 248001

scale and duration of the subcontract works.

3. The Contractor shall carry out monthly general meetings and give out safety awards to deserving laborers employed in the Project as a motivation for all to be more safety conscious.

h. Plant, equipment and qualified personnel

All construction plants and equipment used on or around the site shall be fitted with appropriate safety devices. These shall include, but will not be limited to:

1. Effective safety catches for crane hooks and other lifting devices;
2. Functioning automatic warning devices and, where applicable, an up-to-date test certificate for cranes and hoists.

All construction plants and equipment used on or around the site shall be operated by suitably qualified personnel.

2.6.10 Supervision of protection of environment

The Contractor shall take all reasonable steps to protect the environment on and off the site and to avoid damage or nuisance to persons, private and/ or public properties or others resulting from pollution, noise, vibration or other causes arising as a consequence of his methods of operation. All operations shall conform to the requirements of the government and local authorities in India dealing with environmental matters.

a. Controlling hazards

The Contractor shall be responsible for the protection and monitoring of the environment to avoid, or else minimize adverse impact to it.

a.1 Storage on site

- (i) Materials and equipment on site shall be stored in a manner so as to prevent damage to the site and adjacent areas, and minimize hazards to persons, materials and equipment and all temporary and permanent works. Storage areas shall be kept organized, neat and tidy.
- (ii) Areas assigned for carrying out permanent works shall not be used to store materials, plant and equipment, nor used as access to storage areas without prior approval of the Engineer.
- (iii) Hazardous materials (including fuel and oil) shall be stored and handled only within an area set aside specifically for this purpose. This area shall be enclosed from the remainder of the site with waterproof concrete flooring and rainproof roof, so as to contain any spillage. It shall also be clearly marked and display signs installed at a close distance from the storage area to warn unauthorized workers and visitors to stay away. The area shall be located away from any natural waterways, drainage lines and open drains. In case of petroleum fuel and oil, a collection basin is to be installed in the storage area to gather any spillages, and to facilitate the recovery of the petroleum products for reuse or proper disposal using government licensed recyclers or otherwise.

a.2 Noise and vibration

- (i) The Contractor shall abide by the Central Pollution Control Board (CPCB) regulations and



[Signature]
Chief Engineer
 Technical Cooperation Project
 Uttarakhand Forest Resource Management Project
 NTFP Centre, 49, IT Park
 Dehradun-248001

other applicable laws and regulations related to noise and vibration levels.

- (ii) The Contractor shall take all practical precautions to minimize noise resulting from work under the contract, especially at sites adjacent to residential and institutional areas, from polluting such areas and shall fit all equipment with noise suppressors so that noise levels are minimized. Similarly, as much as practicable, construction methods that produce minimal vibration be adopted, most especially in sites adjacent to residential and institutional areas where possible damage to the structures due to vibration may occur.

a.3 Disposal of surplus soil

Surplus soil shall be transported and disposed to a designated place mentioned in the Construction Plan approved by the Engineer and shall not be dumped in public or private land near the construction area.

a.4 Disposal of contaminants

Solid, liquid and gaseous contaminants shall be disposed in accordance with relevant laws in India and contractual requirements. Non-toxic and/ or non-hazardous liquid waste shall be stored in approved containers for transport and disposed at locations approved by the Engineer and local authorities. Non-toxic and/ or hazardous solid wastes shall be disposed by removal from site, transport and depositing in approved locations. Toxic and hazardous wastes must be temporarily stored using suitable containers at a designated place authorized by the Engineer and local authorities, and disposed through a government-licensed collection agent or otherwise.

a.5 Disposal of refuse

The Contractor shall take adequate measures to ensure the site and associated areas are maintained in a clean and orderly condition. Provisions shall be made for daily removal of rubbish, debris, surplus materials, etc., and for the stacking and storing of materials in authorized locations.

a.6 Dust control

Dust screens and/ or watering of open and unpaved areas shall be arranged to control dust and eliminate public health issues and/ or nuisance to adjoining residential and institutional areas, National Highways often used by commuters, and natural habitats frequented by wildlife during the period of the works.

a.7 Water

- (i) Water removal

Surplus water shall be promptly removed from site by draining off or by mechanical means to keep the works reasonably dry so as not to interfere with construction work. The water removed from the site shall be kept reasonably free of soil, oil/ petroleum and other debris, and the discharge shall not adversely affect the adjoining landowner's residential and livelihood assets, or pose to be a pollution hazard to waterways and farmlands.



Chief Engineer
Technical Cooperation Project
Uttarakhand Forest Resource Management Project
NTFP Centre, 49, IT Park
Dehradun-248001

(ii) Water quality

The Contractor shall ensure that construction activities do not have a detrimental impact on the water quality of surface or groundwater in the areas adjoining the site. Specific measures shall be adopted to prevent the discharge of contaminated runoff from the site. When necessary, potable water source of local people, such as springs located immediately downslope of the site, shall be provided with protection ("spring box") from contaminants originating from construction works.

(iii) Contaminated water

All water contaminated by fuel, oil, chemicals or hazardous waste shall be subjected to proper treatment such as an oil-water separator or other device acceptable to the Engineer, before being discharged into storm water or natural drainage systems. The Contractor will temporarily store the hazardous liquid materials in a suitable container, ready for disposal as prescribed in subsection above.

(iv) Siltation

All drains, streams, and waterways shall be kept clear from mud, silt and other obstructions arising from the execution of work under the contract. Soil and other debris removed from the drains, streams and waterways are to be deposited by the Contractor in suitable areas subject to the approval of the Engineer and concerned local authorities. The Contractor shall ensure that effective construction practices are employed to minimize siltation to the Engineer's satisfaction.

b. Protection of the works

The Contractor shall safeguard and protect the works and materials stored for use in the permanent works until the works have been handed over to the employer. The Contractor shall manage all persons deployed at the site and provide adequate security to protect the works.

The Contractor shall ensure that access is maintained at all times to areas adjacent to the site, unless otherwise instructed by the Engineer.

c. Soil erosion

Control measures may include:

- (i) Install sediment filter, fences, hay bale filters, drains, filter strips, grass outlets, sediment transport basin traps around culverts, drains, soil stockpiles and all other areas that may have the potential to erode or be affected by soil erosion;
- (ii) Install catch drains, slope drains and nearby dissipaters in conjunction with sediment traps installed to divert storm water around the site;
- (iii) Stabilize by grass, materials (excluding pavements and screenings) stockpiled for periods longer than one month;
- (iv) Stabilize disturbed areas using measures such as drains and batters;
- (v) Minimize as much as practicable, the removal of existing vegetation within and around the project area at any time; and



[Signature]
 Chief Engineer
 Technical Cooperation Project
 Uttarakhand Forest Resource Management Project
 NTFP Centre, 49, IT Park
 Dehradun-248001

- (vi) Plan the execution of work under the contract in stages to minimize soil erosion during continuous periods of rainfall that will cause heavy run-off.

Soil erosion control devices shall be regularly inspected and maintained, especially after heavy and/or continuous periods of rain.

d. Soil contamination

The Contractor shall undertake all practicable control measures to prevent the contamination of the soil in and around the site.

d.1 Acceptance of clean filling material

All filling material to be imported and used on the site shall be free from contamination.

d.2 Fuel chemicals and other hazardous materials

All practicable steps shall be taken to ensure contamination of soil does not occur through: fueling; maintenance of vehicles or equipment; storage of fuel, chemicals, and other hazardous materials; and spillage of such materials on to the soil, by ensuring all the above activities are conducted in bounded or sealed areas.

d.3 Clean up of soil contamination

All soils contaminated during construction shall be cleaned by the Contractor to the satisfaction of the Engineer, and at no cost to the employer.

Any contaminated soil material (whether or not contaminated by the Contractor) shall be removed from the site in an approved manner to prevent further pollution.

d.4 Installation of oil separators

The Contractor shall install oil separator to prevent fuel, oil and other petroleum products from spilling into the existing drainage lines and then into the adjacent soil, which will result in its (soil) contamination.

2.6.11 Progress meeting (monthly, weekly, etc.)

In order to implement construction work smoothly, regular meetings as shown in Table 5, shall be held. The Contractor shall prepare and submit the draft of minutes of the meeting to be approved by the Engineer. Agenda of weekly meeting may be as follows:

- (i) Review of previous meeting
- (ii) Progress of this week
- (iii) Schedule for next week
- (iv) Materials, suppliers and subcontractors
- (v) Survey and setting out
- (vi) Personnel and site establishment



Chief Engineer
Technical Cooperation Project
Uttarakhand Forest Resource Management Project
NTFP Centre, 49, IT Park
Dehradun-248001

- (vii) Contractual matters
- (viii) Payment and certification
- (ix) Technical issues
- (x) Drawings and information
- (xi) Safety
- (xii) Letters and documents

Table 5: Regular Meeting

No.	Name	Time	Venue	Participants
1	Monthly meeting	Beginning of every month	TCP	Project director, deputy project director, chief engineer, procurement engineer, quantity surveyor, design engineer, surveyor, entire Task Team, Contractor
2	Weekly meeting	Friday of every week	Task Team office at each model site	Task Team, field Engineers, Contractor

2.6.12 Monthly progress report

The Contractor shall submit a Monthly Progress Report in the format as shown in the Annex, in 10 sets, no later than the fifth calendar day of each month. The report shall describe all works performed up to, and including, the last day of the preceding month. The report shall constitute the fundamental document for the procedure of each progress payment; therefore, the reviewed and approved report shall be attached to each Statement and Payment Certificate.

a. Requirements for the report's contents

1. The report shall include a summarized description of the major activities performed in the month. The report shall contain, but will not be limited to, the following:
 - The activities that were completed in the month, including their actual start and completion dates;
 - The activities that are currently under progress;
 - The time (expressed in calendar days) required to complete each activity that is currently under progress;
 - Current and anticipated problems and delaying factors, their effect on the construction schedule, and the proposed corrective actions; and
 - Satisfactory evidence to substantiate the completion of such work that was reported as completed but is not apparent to be so to the Engineer.
2. The report shall include information and data specified above. If the Engineer considers it is necessary to track the progress and/ or other requirements of the works, he may, at any time,

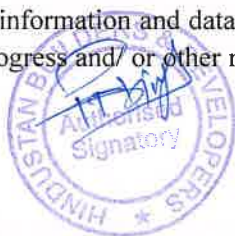

[Signature]
Chief Engineer
 Technical Cooperation Project
 Uttarakhand Forest Resource Management Project
 NTFP Centre, 49, IT Park
 Dehradun, Uttarakhand

request the Contractor to include other additional information in the Report.

3. The Report shall consist basic information and data required in all the submittals ordered by each section of the Specifications and the Conditions of Contract, including, but not limited to, the following:
 - Mobilization, staking-out, photographs and video, etc.
 - Construction photographs and video recording, and other submittals made during the month.
 - Materials approval schedule, drawings schedule, monitoring of submittals, etc.
 - The program, schedule, cashflow, etc.
 - Safety, traffic control, temporary roads, traffic maintenance and protection, etc.
 - Laboratory testing and results, quality control, materials control, etc.
 - Environment aspects, etc.
 - Aspects related to the works, submittals, etc.
4. The following items shall be specifically included in the report:
 - (i) Quality Control Summary: Shall include a summary of related activities performed during the month, addressing quality control problems, outstanding deficiencies, and shall include a summary of all quality control tests, and test results.
 - (ii) Safety Summary: Prepared by the Contractor's Accident Prevention Officer, including a summary of related activities performed during the month, addressing problems on safety, traffic and environmental control, other restraints and any accident.
 - (iii) Equipment Report: Listing in tabular format all equipment on site since the commencement of work, up to the end of the report period, including those of the Contractor, subcontractors and suppliers. The tabulation shall identify the type, make, model, and capacity (if applicable) of equipment, and indicate the date the equipment arrived on site and the date the equipment left the site. In addition, the listing shall note if the equipment is in operation or not. For any equipment not in operation during the report period, the Contractor shall note the period when the equipment was not in operation and reasons for the same.
 - (iv) Work Force Tabulation: Listing in tabular format all staff mobilized on site since the commencement of work, up to the end of the report period, including those of the Contractor, subcontractors and suppliers. The listing shall include the names of all staff personnel, their company affiliation, their position, and nationality.
 - (v) Updated Schedule and Cash-Flow: Showing in the approved bar chart format for the Schedule Critical Path Method (CPM), the progress of the works referring to the approved schedule, and the progress of payments as per the updated Cash-Flow Curve ("S" curve), with an attached copy of the Summary Sheet of Payment Certificate corresponding to the report.

b. Progress photographs

A minimum of twenty-four (24) digital progress photographs with required captions shall be taken



Chief Engineer
Technical Cooperation Project
Uttarakhand Forest Resource Management Project
NTFP Centre, 49, IT Park
Dehradun-248001

for each location every month. The Contractor shall also supply the digital photograph data for all photographs on CDR/W disk or equivalent, together with a record in a form acceptable to the Engineer, identifying the date, location and activity to which each photograph relates. These will serve as a permanent record of documentation for the works. The photographs will be in color, high-resolution and of dimensions 200mmx150mm.

The Contractor shall print digital photographs in suitable albums of good quality and supply four sets of the albums (three for the client, and one for the Engineer) as directed by the Engineer. The digital data of the photographs shall be the property of the employer and no prints from these may be supplied to anyone unless it is under the written authority of the employer or the Engineer.

2.6.13 Instruction and warning

Supervision shall be conducted accordingly with the progress of work. However, in case of any failure such as delay of schedule, poor quality, lack of safety measures, etc. caused by the lack of construction management, such as delay in submission of necessary documents, lack of appropriate instructions to the field workers, lack of countermeasures against the instruction of the Engineer, etc. occur, the Engineer shall take the following steps in regards to the contractor:

Step 1: Engineer shall give verbal instruction on/ off site.

Step 2: Engineer shall give verbal instruction again at the weekly meeting, which shall be recorded in the minutes of meeting.

Step 3: Seven days after Step 2, the Engineer shall issue the instructions in writing and give verbal instructions again at the weekly meeting, which shall be recorded in the minutes of meeting.

Step 4: Fourteen days after Step 2, Engineer shall issue the warning in writing.

Step 5: Twenty-one days after Step 2, the Engineer shall issue instructions to submit the plan of rectification for lacking areas.

Step 6: After the next month of Step 1, the Engineer shall include the issue of instruction into the agenda of monthly meeting attended by UFRMP, Engineer and the Contractor, and it shall be recorded in the minutes of meeting.

Step 7: Ninety days after Step 2, the Engineer shall issue a letter to stop work, or to replace the Contractor's representative.

2.6.14 Management of supervision documents

The Engineer shall keep the following documents shown in Table 6 in his files.

Table 6: Filing of supervision documents

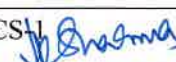
File No.	Document	Place to be kept	Format
A	Letter from Contractor to Engineer	Site, TCP office	
B	Letter from Engineer to Contractor	Site, TCP office	
C	Other letters	Site, TCP office	
D	Approved construction plan	Site, TCP office	OCSH 



E	Record of submission and approval of material	Site, TCP office	QCS-5
F	Record of submission and approval of shop drawing	Site, TCP office	QCS-6
G	Record of request and results of quality control and inspection	Site, TCP office	QCS-8– QCS-13
H	Instructions to the Contractor	Site, TCP office	QCS-3
I	Record of request and results of measurement	Site, TCP office	
J	Certificate for payment	Site, TCP office	
K	Monthly Project Health and Safety Plan by the Contractor	Site, TCP office	SCS-2
L-1	Weekly progress report by the Contractor	Site, TCP office	QCS-14
L-2	Monthly progress report by the Contractor	Site, TCP office	QCS-15
M	Daily safety check sheet for slope work by the Contractor	Site, TCP office	SCS-3
N	Monthly safety report by the Contractor	Site, TCP office	SCS-4
O-1	Minutes of weekly meeting	Site, TCP office	
O-2	Minutes of monthly and other meetings	Site, TCP office	

2.6.15 As built documents

As-built documents to be submitted by the Contractor shall be as follows. The Engineer may request the Contractor to submit other documents if necessary.

- As-built drawings
- Results of the test and inspections
- Construction photographs

2.6.16 Final inspection

A final inspection shall be conducted upon the submission of request for final inspection and as-built documents with the attendance of the Engineer, Task Team and Contractor. In case any defect is found during the inspection, re-inspection shall be conducted upon request by the Contractor after repairing the defects. The Engineer shall issue the certificate of approval after final inspection.

2.6.17 Completion certificate

Project director shall issue a Completion Certificate upon approval of final inspection.



[Signature]
 Chief Engineer
 Technical Cooperation Project
 Uttarakhand Forest Resource Management Project
 NTFP Centre, 49, IT Park
 Dehradun-248001

2.6.18 Release of performance security

The performance security shall be released after one year, only on the condition that no modifications or repairs are pending on part of the contractor at any of the sites. A no-objection certificate shall be issued by TCP for the release of performance security.

3 Quality control sheet (QCS)

The following format shall be used for the supervision of quality control by the Engineer and the Contractor.

- QCS-1: Site order book
- QCS-2: Hindrance register
- QCS-3: Material approval register
- QCS-4: Drawing / revised drawing approval register
- QCS-5: Inspection register
- QCS-6: Cement register
- QCS-7: Steel register
- QCS-8: Aggregate sieve analysis (nominal size)
- QCS-9: Silt content of fine sand / coarse sand
- QCS-10: Slump test
- QCS-11: Cube test
- QCS-12: Weekly/ monthly progress report

4 Safety control sheet (SCS)

The following format shall be used for the supervision of safety control by the Engineer and the Contractor.

- SCS-1: Project Health and Safety Plan
- SCS-2: Monthly Project Health and Safety Plan
- SCS-3: Daily Safety Check Sheet for Slope Work
- SCS-4: Monthly Safety Report



Chief Engineer
Technical Cooperation Project
Uttarakhand Forest Resource Management Project
NTFP Centre, 49, IT Park
Dehradun-248001

Project Health and Safety Plan

Site Name

Month Work Item	Jan.	Feb.	Mar.	Apr.	May	Jun.	Jul.	Aug.	Remark
Safety Activity									Daily safety work cycle
Mobilization									1. Safety meeting 8:00-8:05
									2. Radio exercise 8:05-8:10
									3. KY meeting 8:10-8:15
									4. Safety check before start work 8:15-8:20
Main Program									5. Workina program meeting 13:00-13:30
									6. Safety patrol by Manager 15:00-15:30
Equipment, material, etc.									7. Clearing and cleaning 5 minutes before finish
									8. Finish work (check & report)
									9. Safety education & training Once a month (the 3rd Monday)
									10. Accident preventing meeting Once a month (the 4th Friday)

Risk evaluation	Severity		Possibility		Score	
	1	2	1	2	1	2
Serious (death, etc.)	5	5	Very high	5	5	5
Medium (long term hospital)	4	4	High	4	4	4
Light (4 days leave or more)	3	3	Medium	3	3	3
Light (less than 4 days)	2	2	Low	2	2	2
Minor (no leave)	1	1	Very low	1	1	1

Result and countermeasure	
Total score (=A*B)	Grade
20 ~ 25	IV
10 ~ 19	III
5 ~ 9	II
0 ~ 4	I

Risk evaluation for expected accident	Evaluate		Score		Possibility		Severity		No.	
	Score	Possibility	Severity	No.	Score	Possibility	Severity	No.	Score	Possibility
Countermeasure against accidents to reduce the risk										

Countermeasure against accidents to reduce the risk	Evaluate		Score		Possibility		Severity		No.	
	Score	Possibility	Severity	No.	Score	Possibility	Severity	No.	Score	Possibility
Re-evaluation after countermeasure *Conducting for Grade III and IV before evaluation										

Chief Engineer
 Technical Cooperation Project
 Uttarakhand Forest Resource Management Project
 NITFP Centre, 49, IT Park
 Dehradun-248001



Monthly Project Health and Safety Plan

Work Item	Date-day	Month of: _____												Contractor name		signature																
		1	2	3	4	5	6	7	8	9	10	11	12	13	14		15	16	17	18	19	20	21	22	23	24	25	26	27	28	29	30
Health and safety events		Statistics for safety As of (DD/MM/YYYY):		Total man-hours worked		Frequency rate		Severity		No. of accident		As of: (DD/MM/YYYY)		Contract amount		Contract period (DD/MM/YYYY)		Name of subcontractor with the number of labours and equipment (daily average)		Company name		labor no.		Type and capacity of equipment		Nos.						
		Month of: _____		Since: (DD/MM/YYYY)		No. of accident		As of: (DD/MM/YYYY)		Contract amount		Contract period (DD/MM/YYYY)		Name of subcontractor with the number of labours and equipment (daily average)		Company name		labor no.		Type and capacity of equipment		Nos.										
Expected accidents		Work progress		No accident period		Severity		As of: (DD/MM/YYYY)		Contract amount		Contract period (DD/MM/YYYY)		Name of subcontractor with the number of labours and equipment (daily average)		Company name		labor no.		Type and capacity of equipment		Nos.										
		Site name: _____		No accident period		Severity		As of: (DD/MM/YYYY)		Contract amount		Contract period (DD/MM/YYYY)		Name of subcontractor with the number of labours and equipment (daily average)		Company name		labor no.		Type and capacity of equipment		Nos.										
Risk evaluation for expected accident		Work progress		No accident period		Severity		As of: (DD/MM/YYYY)		Contract amount		Contract period (DD/MM/YYYY)		Name of subcontractor with the number of labours and equipment (daily average)		Company name		labor no.		Type and capacity of equipment		Nos.										
		Site name: _____		No accident period		Severity		As of: (DD/MM/YYYY)		Contract amount		Contract period (DD/MM/YYYY)		Name of subcontractor with the number of labours and equipment (daily average)		Company name		labor no.		Type and capacity of equipment		Nos.										
Countermeasure against accidents to reduce the risk		Work progress		No accident period		Severity		As of: (DD/MM/YYYY)		Contract amount		Contract period (DD/MM/YYYY)		Name of subcontractor with the number of labours and equipment (daily average)		Company name		labor no.		Type and capacity of equipment		Nos.										
		Site name: _____		No accident period		Severity		As of: (DD/MM/YYYY)		Contract amount		Contract period (DD/MM/YYYY)		Name of subcontractor with the number of labours and equipment (daily average)		Company name		labor no.		Type and capacity of equipment		Nos.										
Re-evaluation after countermeasure		Work progress		No accident period		Severity		As of: (DD/MM/YYYY)		Contract amount		Contract period (DD/MM/YYYY)		Name of subcontractor with the number of labours and equipment (daily average)		Company name		labor no.		Type and capacity of equipment		Nos.										
		Site name: _____		No accident period		Severity		As of: (DD/MM/YYYY)		Contract amount		Contract period (DD/MM/YYYY)		Name of subcontractor with the number of labours and equipment (daily average)		Company name		labor no.		Type and capacity of equipment		Nos.										

Chief Engineer
 Technical Cooperation Project
 Uttarakhand Forest Resource Management Project
 NTFP Centre, 49, IT Park
 Dehradun-248001

Signature: _____

Stamp: HINDUSTAN ENGINEERS DEVELOPERS Signatory

*Continue countermeasure improving up to Grade II

Severity	Score	Possibility	Re-evaluate
Very high	5	Very high	Score
High	4	High	Possibility
Medium (long term hospital)	3	Medium	Severity
Medium (4 days leave or more)	3	Medium	No.
Light (less than 4 days)	2	low	Re-evaluate
Minor (no leave)	1	very low	Score
			Possibility
			Severity
			No.

Result and countermeasure	
Total score (=A*B)	Countermeasure
20~25	Countermeasures against major construction method, equipment, etc.
10~19	Countermeasures against working procedure and detail including method, equipment, etc.
5~9	General countermeasure
0~4	Not necessary

Daily Safety Check Sheet for Cliff and Slope Work

Date: _____

Site: _____

Contractor: _____

Engineer: _____

☆ Restricted area		
• Is the restricted area been surrounded by ropes, etc. and indicated by sign board, etc.?	<input type="checkbox"/> Yes	<input type="checkbox"/> No
☆ Selection of licensed worker		
• Is the leader of excavation work designated and noticed on the notice board?	<input type="checkbox"/> Yes	<input type="checkbox"/> No
• Is the license to operate the using equipment kept by the operator checked?	<input type="checkbox"/> Yes	<input type="checkbox"/> No
☆ Keeping safety for working space		
< Working platform and pathway >		
• Are the safety stairs, ladders, lifts, etc. installed?	<input type="checkbox"/> Yes	<input type="checkbox"/> No
• Has the safety condition on the cut slope, filling slope, slope shoulder, access road, etc. been confirmed?	<input type="checkbox"/> Yes	<input type="checkbox"/> No
< Platform >		
• Is the platform with handrail for working on the cliff or slope installed?	<input type="checkbox"/> Yes	<input type="checkbox"/> No
• is the fall down protection fence installed on the shoulder and catwalk of slope?	<input type="checkbox"/> Yes	<input type="checkbox"/> No
< Lifeline, safety belt >		
• Have lifelines, safety belts and lanyards been inspected by the check list by the qualified person and replaced with good one if defected?	<input type="checkbox"/> Yes	<input type="checkbox"/> No
• Has the lifeline been installed properly in accordance with the construction plan?	<input type="checkbox"/> Yes	<input type="checkbox"/> No
• Has the sub lifeline by safety block etc. been installed?	<input type="checkbox"/> Yes	<input type="checkbox"/> No
• Is the safety block functioning properly without defects of the wire, etc.?	<input type="checkbox"/> Yes	<input type="checkbox"/> No
• Is lifeline fixed with at least 2 points of strong trees or well hammered anchor pins?	<input type="checkbox"/> Yes	<input type="checkbox"/> No
• Is the position where the rope of lifeline might be worn out protected by the cover?	<input type="checkbox"/> Yes	<input type="checkbox"/> No
• Is the rope of lifeline extended up to the end of slope or catwalk with falling protection fence?	<input type="checkbox"/> Yes	<input type="checkbox"/> No
• Is the one set of lifeline not used for more than one person?	<input type="checkbox"/> Yes	<input type="checkbox"/> No
• Is the slope type safety belt used?	<input type="checkbox"/> Yes	<input type="checkbox"/> No
• Have workers been instructed to always keep the connection between safety belt and lifeline on the slope.	<input type="checkbox"/> Yes	<input type="checkbox"/> No
• Has the strength of the support of safety belt been confirmed?	<input type="checkbox"/> Yes	<input type="checkbox"/> No
☆ Safety instruction		
• Has the procedure of today's work been informed to the workers?	<input type="checkbox"/> Yes	<input type="checkbox"/> No
• Has the method to use the lifeline, safety belt, lanyard grip, etc. been explained and trained to the workers?	<input type="checkbox"/> Yes	<input type="checkbox"/> No
• Has the method of proper wearing of helmet, safety shoes, etc. been instructed?	<input type="checkbox"/> Yes	<input type="checkbox"/> No
• Have the workers been instructed to re-check the lifeline, safety belt and lanyard when they realize the abnormal functioning?	<input type="checkbox"/> Yes	<input type="checkbox"/> No
• Has the record of safety education for the workers who never worked on this site been checked?	<input type="checkbox"/> Yes	<input type="checkbox"/> No
☆ Weather condition		
• Has the suspension of work due to weather condition been considered?	<input type="checkbox"/> Yes	<input type="checkbox"/> No
☆ Instruction in the meeting		
• Has workers health condition been checked? Has the arrangement of workers been conducted adequately?	<input type="checkbox"/> Yes	<input type="checkbox"/> No
• Have the shoes, wears and helmets of workers checked whether suitable for work?	<input type="checkbox"/> Yes	<input type="checkbox"/> No
• Has the restricted area been informed? Have unscheduled works and up-and-down simultaneous works been prohibited?	<input type="checkbox"/> Yes	<input type="checkbox"/> No
• Is the instruction based on the result of the safety program meeting?	<input type="checkbox"/> Yes	<input type="checkbox"/> No
• Is the equipment are used in accordance with the construction plan.	<input type="checkbox"/> Yes	<input type="checkbox"/> No
• Is the equipment are used been checked and repaired?	<input type="checkbox"/> Yes	<input type="checkbox"/> No
• Has the operator been instructed working area, working root, working method, etc.?	<input type="checkbox"/> Yes	<input type="checkbox"/> No
• Has the expected hazardous conditions been discussed before starting the work?	<input type="checkbox"/> Yes	<input type="checkbox"/> No
• Is there any new problem or caution required on the work?	<input type="checkbox"/> Yes	<input type="checkbox"/> No
• Other necessary issues	<input type="checkbox"/> Yes	<input type="checkbox"/> No



(Signature)
Chief Engineer

Technical Cooperation Project
 Uttarakhand Forest Resource Management Project
 NTFP Centre, 49, IT Park

SCS-4

Monthly Safety Report

Contents

1	Introduction	1
2	Contract Detail.....	1
3	Work Progress by Site during the Month of August 2019	1
4	Monthly Safety Statistics.....	1
5	Presence of Accident Prevention Officer.....	1
6	Safety Activity by Site.....	1
7	Status of Safety Document.....	1
8	Arrangement of First Aid Point.....	1
9	Safety Awareness Activity.....	2
10	Weekly Monitoring on Safety Measures.....	2
11	Arrangement of Sign Board	2
12	Stock of Safety Tools and Equipment.....	3
13	Photo Gallery	3
	Table 1: Monthly Safety Statistics	1
	Table 2: Presence of Accident Prevention Officer.....	1
	Table 3: Status of Safety Document.....	1
	Table 4: Safety Awareness Activity of the Month	2
	Table 5: Weekly Monitoring Result on Safety Measures	2
	Table 6: Arrangement of Sign Board	2
	Table 7: Stock of Safety Equipment	3



Chief Engineer
 Technical Cooperation Project
 Uttarakhand Forest Resource Management Project
 NTFP Centre, 49, IT Park
 Dehradun-248001

- 1 Introduction
- 2 Contract Detail
- 3 Work Progress by Site during the Month of
- 4 Monthly Safety Statistics

Table 1: Monthly Safety Statistics

No.	Indicator	Unit	This month	Accumulate
1	Total man-hour worked	hour		
2	Fatal accident occurred	time		
3	Leave accident occurred	time		
4	Non-leave accident occurred	time		
5	Number of fatal and leave person by accident	person		
6	Man-days lost by accident (7500 days for fatal)	days		
7	Frequency rate (= (5) / (1) x 1000000)			
8	Severity rate (= (6) / (1) x 1000)			
9	First aid treatment occurred	time		
10	Near miss occurred	time		
11	Tool box meeting conducted	time		
12	Safety patrol conducted	time		
13	Safety training conducted	time		
14	Safety awareness workshop conducted	time		

5 Presence of Accident Prevention Officer

Table 2: Presence of Accident Prevention Officer

No.	Location	Name	Presence (days)	Percentage of presence (%) of the month
1	Jokla			

6 Safety Activity by Site

7 Status of Safety Document

Table 3: Status of Safety Document

No.	Document	Version No.	Date of submit	Status
1	Project health and safety plan			Approved
2	Safety arrangement plan			
3	Monthly health and safety plan for			
4	Monthly Safety Report for August 2019			

8 Arrangement of First Aid Point



K. Sharma
 Chief Engineer
 Technical Cooperation Project
 Uttarakhand Forest Resource Management Project
 NTFP Centre, 49, IT Park
 Dehradun-248001

9 Safety Awareness Activity

Table 4: Safety Awareness Activity of the Month

No.	Activity type	Topics	Date	Attendance (person)		Coordinator	Location
				Officer	Labour		
1	Tool box meeting						
2	Safety training						
3	Safety workshop						
4							
5							

10 Weekly Monitoring on Safety Measures

Table 5: Weekly Monitoring Result on Safety Measures

No.	Safety Measures	Location	Remark
1	Use of PEP (Personal Protective Equipment)	O	
2	Boundary barricading	X	
3	Traffic diversion and control	NA	
4	Arrangement of flag men	O	
5	Arrangement of sign boards	X	
6	Arrangement of safety posters	NA	
7	Safety in the night time	O	
	Legend:		
O	Satisfactory		
X	Not satisfactory		
NA	Not applicable		

11 Arrangement of Sign Board

Table 6: Arrangement of Sign Board

No.	Type of sign board	Quantity (piece)
		Total
1	General safety	
2	Site safety	
3	Warning	
4	Traffic control (Speed Limit)	
5	Traffic control (Direction Boards)	



J. Sharma
Chief Engineer

Technical Cooperation Project
Uttarakhand Forest Resource Management Project
NTFP Centre, 49, IT Park,
Dehradun-248001

12 Stock of Safety Tools and Equipment

Table 7: Stock of Safety Equipment

No.	Description	Unit	Total stock	Opening balance at the beginning of month	Distributed this month	Closing balance at the end of month	Remark
1	Safety helmet	nos					
2	Safety jacket	nos					
3	Safety shoes	nos					
4	Rubber boots	nos					
5	Hand gloves	nos					
6	Safety goggles	nos					
7	Dust mask	nos					
8	Safety belt	nos					
9	Lanyard grip	nos					
10	Safety ropes	m					
11	Rain coat	nos					
12	Umbrella	nos					
13	Barricade tape	kg					
14	Safety road cone	nos					
15	Safety flag	nos					
16	Blinking light	nos					
17	Baton torch	nos					
18	Hand held radio set	set					
19	Whistle	nos					
20	Fire extinguisher	nos					
21	First aid kit	set					

13 Photo Gallery



[Signature]
Chief Engineer
 Technical Cooperation Project
 Uttarakhand Forest Resource Management Project
 NTFP Centre, 49, IT Park
 Dehradun-248001

